



UNITED STATES

FINANCIAL SECTOR ASSESSMENT PROGRAM

July 2015

SYSTEMIC RISK OVERSIGHT AND MANAGEMENT— TECHNICAL NOTE

This Technical Note on Systemic Risk Oversight and Management on the United States was prepared by a staff team of the International Monetary Fund. It is based on the information available at the time it was completed in June 2015.

Copies of this report are available to the public from

International Monetary Fund • Publication Services

PO Box 92780 • Washington, D.C. 20090

Telephone: (202) 623-7430 • Fax: (202) 623-7201

E-mail: publications@imf.org Web: <http://www.imf.org>

Price: \$18.00 per printed copy

International Monetary Fund
Washington, D.C.



UNITED STATES

FINANCIAL SECTOR ASSESSMENT PROGRAM

June 2015

TECHNICAL NOTE

SYSTEMIC RISK OVERSIGHT AND MANAGEMENT

Prepared By
**Monetary and Capital Markets
Department**

This Technical Note was prepared in the context of an IMF Financial Sector Assessment Program (FSAP) mission to the United States of America, led by Aditya Narain and overseen by the Monetary and Capital Markets Department, IMF. Further information on the FSAP can be found at <http://www.imf.org/external/np/fsap/fssa.aspx>

CONTENTS

GLOSSARY	4
EXECUTIVE SUMMARY	6
SYSTEMIC RISK OVERSIGHT AND MANAGEMENT OVERVIEW	9
A. Overview	9
B. Remit, Responsibilities and Organization of FSOC	9
C. Strengthening Systemic Risk Identification in the United States	16
D. Addressing Identified Threats to Financial Stability	22
E. Systemic Risks—A Closer Look at Some Key Concerns	28
SYSTEMIC LIQUIDITY AND LIQUIDITY BACKSTOPS	28
A. Introduction	28
B. Tri-party Repo Infrastructure	29
C. Repo Safe Harbors	30
D. Broker-dealers	31
E. Money Market Mutual Funds	32
F. Fed Exit and Financial Stability	35
G. Data Gaps	37
H. Liquidity Backstops	38
INVESTMENT FUNDS AND SYSTEMIC RISK	42
A. Asset Managers and Market Liquidity Risks	42
B. Securities Lending by Mutual Funds	46
SYSTEMIC RISK OVERSIGHT OF FINANCIAL MARKET INFRASTRUCTURES	48
A. Overview of FMIs in the United States	48
B. Regulation and Supervision of FMIs	49
C. System-Wide Risks Identification and Management	54
D. Crisis Management Arrangements	56
HOUSING FINANCE	57

BOXES

1. Summary of Major Authorities and Tasks of FSOC _____	11
2. Normalizing Monetary Policy, Reverse Repos and Financial Stability _____	36

FIGURES

1. Intraday Credit as of May 2014 _____	30
2. MMMFs Funds by Type _____	33
3. ONRRP and Selected Interest Rates _____	37
4. TPR Collateral _____	38
5. TPR Haircuts January 2015 _____	38
6. Corporate Bonds Inventory _____	44
7. Sold Assets under Stress and Dealers Inventories _____	44
8. Private Nonfinancial Sector Debt _____	58
9. Mortgage Debt by Holder _____	58
10. Residential Mortgage-Backed Security Issuance _____	59

TABLES

1. Organization, Role and Powers of FSOC and other Macroprudential Oversight Bodies _____	15
2. Primary Supervisory Agency and Application of Enhanced Risk Management Standards for U.S. FMI's _____	51

APPENDICES

1. Remit and Organization of the Financial Stability Oversight Council _____	63
2. The Office of Financial Research _____	66
3. Macroprudential Policy Tools in the United States _____	68
4. Risks and Interconnectedness In and Around TPR _____	71
5. Statistics on Financial Market Infrastructures _____	72
6. FMI Landscape _____	74
7. Cross-Margining Arrangements and CSD Links _____	75
8. Dependencies of Designated FMUs on Commercial Bank Services _____	76

APPENDIX TABLES

1. Statistics on FMI's, 2013 _____	72
2. CCPs Offering OTC Derivatives Clearing _____	73
3. CCP Size of Financial Resources, December 2013 _____	73

Glossary

ACH	Automated Clearing House
AuM	Assets under Management
BHC	Bank Holding Company
BD	Broker-Dealer
CCAR	Comprehensive Capital Analysis and Review
CCP	Central Counterparty
CDS	Credit Default Swap
CFPB	Consumer Financial Protection Bureau
CFTC	Commodity Futures Trading Commission
CHIPS	Clearing House Interbank Payment System
CLS	Continuous Linked Settlement
CME	Chicago Mercantile Exchange
CPSS	Committee on Payment and Settlement Systems (now: CPMI: Committee on Payments and Market Infrastructures)
CRA	Credit Rating Agency
CSD	Central Securities Depository
DIF	Deposit Insurance Fund
DFA	Dodd-Frank Wall Street Reform and Consumer Protection Act
DTC	Depository Trust Company
DTCC	Depository Trust & Clearing Company
ECN	Electronic Communication Network
EM	Emerging Markets
ESRB	European Systemic Risk Board
ETF	Exchange Traded Fund
FATF	Financial Action Task Force
FBO	Foreign Bank Organization
FDIC	Federal Deposit Insurance Corporation
Fed	Federal Reserve System
FHA	Federal Housing Administration
FHFA	Federal Housing Finance Agency
FHLBs	Federal Home Loan Banks
FICC	Fixed Income Clearing Corporation
FIO	Federal Insurance Office
FMI	Financial Market Infrastructure
FMU	Financial Market Utility
FRA	Federal Reserve Act
FRB	Federal Reserve Board
FRBNY	Federal Reserve Bank of New York
FSAP	Financial Sector Assessment Program
FSB	Financial Stability Board
FSOC	Financial Stability Oversight Council
FSSA	Financial System Stability Assessment
FX	Foreign Exchange
GAO	Government Accountability Office
GCF	General Collateral Financing
GFC	Global Financial Crisis of 2008–09
GSE	Government-Sponsored Enterprises

GSIB	Global Systemically Important Banks
GSIFI	Global Systemically Important Financial Institutions
GSII	Global Systemically Important Insurers
HUD	Housing and Urban Development
HY	High Yield
IAIS	International Association of Insurance Supervisors
GFSR	Global Financial Stability Report (IMF)
IASB	International Accounting Standards Board
ICE	Intercontinental Exchange Clear Credit L.L.C
ICP	Insurance Core Principles
ICPF	Insurance Companies and Pension Funds
IOSCO	International Organization of Securities Commissions
KA	Key Attributes of Effective Resolution Regimes for Financial Institutions
LCR	Liquidity Coverage Ratio
LEI	Legal Entity Identifier
LIBOR	London Interbank Offered Rate
LTV	Loan-To-Value
MBS	Mortgage Backed Securities
MF	Mutual Fund
MMMF	Money Market Mutual Fund
MOU	Memorandum of Understanding
NAIC	National Association of Insurance Commissioners
NAV	Net Asset Value
NBFI	Nonbank Financial Institution
NCUA	National Credit Union Administration
NSCC	National Securities Clearing Corporation
OCC	Office of the Comptroller of the Currency
OFR	Office of Financial Research
OIS	Overnight Interest Rate Swap
OLA	Orderly Liquidation Authority
ONRRP	Overnight Reverse Repo
OTC	Over-The-Counter
P&C	Property and Casualty Insurance
PDCF	Primary Dealer Credit Facility
PFMI	CPSS-IOSCO Principles for Financial Market Infrastructures
PLS	Private Label Securitization
PWG	President's Working Group on Financial Markets
QE	Quantitative Easing
QM	Qualified Mortgage
QRM	Qualified Residential Mortgage
RTGS	Real Time Gross Settlement
SEC	Securities and Exchange Commission
SEF	Swap Execution Facility
SIPA	Securities Investor Protection Act
SLHC	Savings and Loans Holding Companies
SSS	Securities Settlement System
TPR	Tri-Party Repo
U.S. GAAP	United States Generally Accepted Accounting Principles
U.S.	United States

EXECUTIVE SUMMARY¹

The importance of enhancing systemic risk oversight and building effective macroprudential tools is widely recognized. In the United States, where the financial markets display a greater degree of heterogeneity than elsewhere, and supervision and regulation are split amongst a range of specialist agencies, the need to build structures that ensure interagency sharing of information, avoid regulatory gaps, obtain a good overview of systemic risks, and develop an effective, cooperative framework to address identified threats to financial stability is particularly evident. This paper reviews those processes in the United States, as well as examining progress to address several important areas of risk which have been identified, particularly in the non-banking sector.

The establishment of the Financial Stability Oversight Council (FSOC) in 2010 filled a major gap in the U.S. financial stability framework, and it is central to the regulatory response to the problems which hit the financial sector in 2007–2009.² The Dodd Frank Act (DFA) gives the Council a range of powers that enable it to respond to emerging threats to financial stability (see Box 1).³ In practice the Council works primarily through enhanced communication, consultation, and coordination of the work of the U.S. financial regulatory agencies; the effectiveness of FSOC relies extensively on the Council's success in building and delivering a collective, common, purpose across the U.S. financial regulatory agencies to identify and address systemic risks and to work together to promote financial stability. The work which the FSOC has undertaken is welcome. However:

- The collective purpose and accountability of FSOC would be strengthened by providing to each member agency and member an explicit mandate to promote financial stability and thus to support the work of FSOC (subject to the mission and objectives of the member agencies and members).⁴
- Further actions are needed to: address data gaps; resolve remaining impediments to data sharing; support coordination and consultation on prudential standards and regulations; enhance risk monitoring frameworks; provide additional clarity on the nature and scale of identified emerging systemic threats; and strengthen the transparency and collective ownership of the actions needed to address identified risks by clarifying and publishing more specific follow-up actions, and outlining where responsibility for delivery lies, including the expected timeline for implementation and reporting of results.

¹ This Technical Note was prepared in the context of the 2015 U.S. Financial Sector Assessment Program (FSAP) by Simon Gray, Deniz Igan, Nigel Jenkinson, Darryl King, Jay Surti, and Froukelien Wendt (all IMF), and Christine Sampic (Banque du France). The FSAP missions took place in two phases between October 2014 and March 2015.

² The Council is supported by the Office of Financial Research (OFR) which has responsibility to standardize the types and formats of data and develop tools for identifying risks, as well as to perform research.

³ The DFA also provides additional authorities to certain FSOC member agencies.

⁴ The DFA defines an FSOC member agency as an agency represented by a voting member of the Council (DFA Section 102).

- The development of the macroprudential toolkit remains a work in progress; FSOC member agencies and members should continue to focus on measures to address the buildup of cyclical and sectoral risks and to strengthen the resilience of financial markets to run risks; as well as clarifying the framework for implementation of macroprudential policies.

Significant steps have been taken by the U.S. authorities to reduce risks in a number of areas, but progress is most advanced in the area of banking sector resilience, and less so in other areas which play a major role in the financial system.

- In the area of Too-Big-to-Fail, progress has been made with FSOC designation, and with heightened prudential standards and enhanced supervision, which together with the development of 'living wills' and resolution legislation and procedures reduce the risk that the material financial distress or activities of an individual firm could pose a threat to U.S. financial stability. At the same time, the DFA restricts the authorities' (and in particular the Fed's) ability to provide a liquidity backstop to individual institutions. This clearly puts an onus on the effectiveness of strengthened prudential standards and recovery and resolution planning. In the transition, until they are fully embedded, the U.S. Treasury, the Fed and other regulatory agencies need to ensure that adequate plans are in place and legal authorities sufficiently clear, to allow for a timely and sufficient response to any problems that may arise in Systemically-Important Financial Institutions (SIFIs), as well as in systemically-important markets.
- Given their increased systemic importance, all risks related to financial market infrastructures (FMIs), in particular central counterparties (CCPs), need to be carefully addressed. Progress is continuing in this area: agencies have substantially increased staff, and regulatory frameworks governing designated Financial Market Utilities (FMUs)⁵ provide for transparency, governance, and strong risk management. It will be important to promptly finalize implementation of the internationally agreed PFMI, through completion of rules and their implementation by FMIs, and by further addressing the potential threat posed by the concentration of service provision by G-SIBs to FMIs. Providing designated FMUs with an account at a Federal Reserve Bank will be an important element of this. System wide risks related to interdependencies and interconnections in the U.S. FMI landscape could be further identified and managed. Finally, recovery and resolution plans for FMIs are at an early stage and authorities are encouraged to continue their efforts to further develop these in line with international guidance.

In principle, there should be no impediment in designating any entity or identifying an activity as systemically important if the entity's failure, distress or excesses or the nature of the activity could cause a major disruption in the financial markets, and consequently subjecting it to higher prudential standards of regulation and supervision or enhanced resolution regimes. In practice, the challenge lies in applying this principle to non-banks such as

⁵ This report follows international usage with the term 'financial market infrastructure (FMI)' while the U.S., including in the DFA, tend to use the term 'financial market utility'. FMIs that are designated as systemically important by the FSOC are referred to as 'designated FMUs' in line with the DFA.

investment funds and to activities such as asset management, which are often managed by agents and where the focus of regulation has mainly been on conduct. The FSOC has been deliberating on this issue, as has the FSB at the international level. It is important that potential risks in these areas are addressed, given the concerns in the present conjuncture about the build-up of systemic risks in non-banks. It should be noted that under Section 112 of the DFA, FSOC can make recommendations in this regard to the primary regulators even in the absence of designation, and it should be prepared to use this authority.

Focusing particularly on the areas of liquidity risks, market based finance, and housing finance, important remaining weaknesses include:⁶

- Reforms to the triparty repo infrastructure have reduced, though not eliminated, a number of risks; and consideration should be given to the use of a central counterparty (CCP) with access to central bank accounts to further reduce risks.
- Money market mutual funds (MMMFs) have been made more resilient, but the use of stable Net Asset Values (NAVs) persists, and even after 2016 may apply to three quarters of the funds managed by MMMFs, allowing both institutional and retail investors to treat these investments as cash-equivalent despite the greater liquidity risks involved than with cash.
- More needs to be done: to strengthen broker-dealer (BD) regulation and supervision (especially since it cannot be assumed the large BDs will remain under Bank Holding Companies (BHCs) forever); to review risk management practices related to securities lending and cash collateral reinvestment (improving data will be a necessary part of this); and to review the impact of coverage of the safe harbor provisions governing repo transactions.
- Expansion of open-ended mutual funds (MF) and exchange traded funds (ETF) in certain products has increased market liquidity risks. These funds' holdings of high yield (HY) corporate bonds, emerging market (EM) debt and bank loans have increased substantially since 2008 even as common metrics of trading liquidity have declined significantly in these products. Structural factors, including money-like investment shares, lack of balance-sheet capacity to meet investor redemption demand, and incentives for investors to herd give cause for concern.
- Important data gaps remain in some significant areas: there are shortfalls not only in the collection of data, but also in the availability and ease of manipulation of data across FSOC members and financial regulatory agencies. Steps taken to address these are welcome, though it is striking that in some—such as bilateral repo, securities lending and asset management—data gathering is still at very early stages.

⁶ The FSAP elsewhere reviews in depth risks to, and the regulation of, the banking, insurance, and securities sectors. See the companion note on Stress Testing as well as the Detailed Assessment Reports of banking and insurance supervision and the regulation of securities markets.

- A comprehensive assessment of financial stability risks from MFs' securities lending and embedded leverage is needed. The FSAP discussions suggest that MFs' investment of cash collateral received in securities' lending is increasingly directed by mandates to MMMFs. While this avoids maturity risks in term repo deals increasingly preferred by dealers, it does not eliminate liquidity risk given that redemptions from such MMMFs could be gated at times of stress.
- Not enough has been done to tackle the structural weaknesses in mortgage markets that were uncovered during the GFC. The legislative reforms of Fannie Mae and Freddie Mac have stalled. It is essential to reinvigorate legislative momentum for comprehensive housing finance reform in line with recent proposals.

SYSTEMIC RISK OVERSIGHT AND MANAGEMENT

OVERVIEW

A. Overview

- 1. Significant structural changes to the framework were introduced in the wake of the global financial crisis.** Most substantially, the FSOC was established in 2010 by the DFA to bring together key U.S. financial regulators to support financial stability. The establishment of the Council was a major landmark. FSOC's establishment also fulfilled a key recommendation of the 2010 FSAP.
- 2. The note describes the role and operations of the Council and its member agencies to promote U.S. financial stability.** In particular, it examines the approaches and capacity of FSOC and the member agencies to identify and respond effectively to evolving systemic risks, as well as the work underway to strengthen the approach to risk identification and enhance the macroprudential policy toolkit. It also explores several major financial stability risks and concerns in greater depth that are not addressed elsewhere in the FSAP: namely, systemic liquidity risks; market based financing issues; risks related to FMIs; and mortgage market risks and options for reform.⁷

B. Remit, Responsibilities and Organization of FSOC

- 3. The establishment of the FSOC in 2010 filled a major gap in the U.S. financial stability framework.** Under the Chairpersonship of the U.S. Treasury Secretary, FSOC brings together the heads of key U.S. financial regulatory agencies to work collaboratively to promote financial stability.⁸ FSOC has three primary purposes, as set out in the DFA: to identify risks to U.S. financial stability; to promote market discipline by eliminating expectations that the government will shield shareholders and counterparties from losses; and to respond to emerging threats to U.S. financial stability (see Appendix 1 on the Remit and Organization of the FSOC).

⁷ These concerns have also been noted by the FSOC in the 2014 FSOC Annual Report.

⁸ The FSOC is supported by a Secretariat and by the Office of Financial Research created by the DFA.

4. FSOC was established as a remedy to well-documented institutional shortcomings and policy failures.⁹ Prior to the creation of the FSOC, U.S. financial regulation and policy was typically focused narrowly on the safety and soundness of individual institutions. In common with failings of regulatory frameworks in other countries, insufficient attention was paid to the buildup of risk across the financial system as a whole through common and concentrated exposures and complex interconnections. Moreover, the complexity of the U.S. regulatory structure, gaps in regulatory frameworks and a weak institutional structure to encourage collaboration and coordination added to the difficulties of developing an accurate picture of and responding to emerging systemic risk.

5. FSOC has been granted authorities and powers by the DFA to support the maintenance of financial stability. In particular, FSOC has authorities to undertake the following six main tasks: to facilitate regulatory coordination among the member agencies; to facilitate information sharing and data collection; to designate nonbank financial companies for consolidated supervision and enhanced prudential standards; to designate systemically important FMUs and payment, clearing or settlement activities for heightened oversight and supervision and to meet enhanced risk management standards; to recommend stricter standards for the largest, most interconnected firms and to make formal recommendations to primary regulators to apply new or heightened standards; and to play a significant role in any determination of whether actions should be taken to break up firms that pose a grave threat to financial stability (see Box 1 on Authorities and Tasks of FSOC).

6. The FSOC is accountable to Congress for the fulfillment of the remit. In particular, it must publish an Annual Report describing the activities of the Council, including an assessment of potential emerging threats to U.S. financial stability and recommendations to enhance the integrity, efficiency, competitiveness and stability of U.S. financial markets, as well as recommendations to promote market discipline and maintain investor confidence.^{10,11} The voting members of the Council must individually sign off that they agree that all reasonable steps are being taken to ensure financial stability, including additional actions described in the Annual Report; or if not, they must specify what further actions they believe should be taken.¹²

7. The Council is supported by a Deputies Committee of senior staff of Council members and member agencies, which meets on average every two weeks to direct and oversee the work of six Committees focused on different aspects of the Council's responsibilities (Appendix Figure 1). FSOC is also supported by a dedicated Secretariat of just over 20 staff currently located in the U.S. Treasury.¹³ Bylaws or rules of organization of the Council and of the Deputies Committee have been

⁹ See the 2010 U.S. FSAP <https://www.imf.org/external/pubs/ft/scr/2010/cr10247.pdf>.

¹⁰ Requirements for material to be included in the Annual Report are specified in DFA Section 112.

¹¹ The Council also provides advice to Congress on legislative reforms. For example, it conducted a study on how best to implement the Volcker rule, and a study on application of the financial sector concentration limit set out by DFA.

¹² To date, the 5 FSOC Annual Reports have each been signed off unanimously by the voting members.

¹³ FSOC Secretariat staff is predominantly from the U.S. Treasury, with one or two on detail from time to time from other FSOC member agencies for short periods.

published by FSOC.¹⁴ Work under way to supplement this information by publishing the governance arrangements and Charters for the individual Committees is helpful.¹⁵

Box 1. Summary of Major Authorities and Tasks of FSOC^{1/}

- **Facilitate Regulatory Coordination:** The Council has a responsibility to facilitate information sharing and coordination among the member agencies regarding domestic financial services policy development, rulemaking, examinations, reporting requirements, and enforcement actions.
- **Facilitate Information Sharing and Collection:** By statute, the Council has a responsibility to facilitate the sharing of data and information. In instances where available data proves insufficient, the Council has the authority to direct the OFR to collect additional information in order to assess risks to the financial stability of the United States. Appendix 2 provides more information on the role of the OFR.
- **Designate Nonbank Financial Companies for Consolidated Supervision and enhanced prudential standards:** The DFA gives the Council the authority to designate nonbank financial companies for consolidated supervision by the Federal Reserve, regardless of their corporate form. Designated companies are required to meet heightened prudential standards set by the Federal Reserve. To date, four nonbank financial companies have been designated by FSOC.^{2/}
- **Designate Systemic Financial Market Utilities (FMUs) and Systemic Payment, Clearing, or Settlement Activities:** The DFA provides the Council with the responsibility to designate FMIs as systemically important. Under the DFA, designated FMUs have to comply with risk management standards prescribed by the Federal Reserve Board (FRB), the Securities and Exchange Commission (SEC), or the Commodity Futures Trading Commission (CFTC) as appropriate. Eight FMIs have so far been designated.^{3/} The Act also authorizes the Council to designate systemically important payment, clearing or settlement activities. That power has not been used to date.
- **Recommend Stricter Standards:** The Council has the authority to recommend stricter standards for the largest, most interconnected firms, including designated nonbank financial companies, as described above. Moreover, where the Council determines that certain practices or activities pose a threat to financial stability, the Council may make formal recommendations to the primary financial regulatory agencies for new or heightened regulatory standards. The Council has taken steps to use the latter facility once—in relation to MMMFs.^{4/} The Council also has the duty to monitor domestic and financial regulatory proposals and developments, as well as to identify gaps in regulation that could pose risks to U.S. financial stability.^{5/}
- **Break up Firms that Pose a Grave Threat to Financial Stability:** The FSOC has a role in any determination whether action should be taken to break up (or take other mitigating actions on) firms that pose a “grave threat” to U.S. financial stability. No actions have so far been taken under this provision.^{6/}

^{1/} See ‘Frequently Asked Questions on the FSOC’ at <http://www.treasury.gov/initiatives/fsoc/about/Pages/default.aspx>. This is not a comprehensive list.

^{2/} AIG, GE Capital, Prudential Financial, and MetLife.

^{3/} Designated FMUs are: the Clearing House Payments Company LLC; Continuous Linked Settlement Bank International (CLS); Chicago Mercantile Exchange (CME); Intercontinental Exchange Clear Credit LLC (ICE); Depository Trust Company (DTC); Fixed Income Clearing Corporation (FICC); National Securities Clearing Corporation (NSCC); and the Options Clearing Corporation.

^{4/} The Council undertook the first steps of the process (available under section 120 of DFA) in late 2012, issuing proposed recommendations for MMMF reform for consultation <http://www.treasury.gov/press-center/press-releases/Pages/tg1764.aspx>. The Council stated at the time that the SEC is best positioned to implement reforms to address the risks that MMMFs present to the economy. The SEC subsequently announced final proposals for reform following a round of public comments in July 2014. The Council in July 2014 announced that it was examining the SEC’s rule and its potential impact on MMMFs and financial stability.

^{5/} DFA Section 112.

^{6/} FSOC is tasked to provide an affirmative vote on such actions, following a determination by the Board of Governors of the Federal Reserve System that a firm poses a grave threat (section 121 of the DFA).

¹⁴ <http://www.treasury.gov/initiatives/fsoc/governance-documents/Pages/default.aspx>.

¹⁵ Apart from the Council and Deputies Committees which are chaired by the U.S Treasury Secretary and a senior Treasury staff member respectively, there are currently no chairs of the other 6 Committees. Meetings of these Committees are facilitated by the FSOC Secretariat.

8. The Council works primarily through enhanced coordination of the work of the U.S. regulatory agencies. A comparison of the structure, remit and powers of FSOC to financial stability oversight bodies in the U.K. and Europe reveals that FSOC has fewer direct powers and tools than in some other jurisdictions (see Table 1). In particular, FSOC does not have ownership and control of macroprudential tools, and while it has the capability of making formal recommendations to regulators under section 120 of DFA, there appear to be tighter restrictions on the use of the instrument than in other jurisdictions.¹⁶ In practice, the vast majority of FSOC recommendations, for example in the Annual Report, are ‘advisory’, although it does have the authority to issue formal (stronger) recommendations. The effectiveness of the Council consequently relies extensively on the Council’s success in building and delivering a collective, common purpose across the U.S. regulatory agencies to take the recommendations forward and to work together to promote financial stability.¹⁷ Appendix 3 provides an overview of macroprudential policy tools in the United States.

9. The broad membership of FSOC reflects the complex web of regulatory bodies in the United States, which was little altered in response to the recent financial crisis.¹⁸ The voting members are the heads of nine authorities with national responsibilities for different aspects of financial regulation, together with an independent member with insurance expertise appointed by the President. Members are advised by the Directors of the OFR and the Federal Insurance Office (FIO)—new U.S. Treasury offices created by DFA—and by nominated representatives of state insurance commissioners, banking supervisors, and securities commissioners.

10. Broad membership helps the Council to draw on input, insights, and expertise from across the complex regulatory structure to assess risks to the overall financial system. The heads of the principal federal banking and market regulatory agencies are voting members of FSOC, alongside the heads of the housing regulatory agency and consumer protection body, while a state banking regulator and a state securities regulator participate as non-voting observers. However, the representation of the insurance industry has had to be structured differently. Given the absence of a parallel federal or national regulatory body, the voting member is an independent member with insurance expertise appointed by the President (while the Federal Insurance Office—which does not have primary regulatory responsibilities—and a state insurance commissioner provide support as non-voting observers). The regulatory structure and representation could mean that insurance issues lack a voice congruent to the systemic importance of the sector. It is not clear how this could be improved without the creation of a federal/national insurance regulatory organization whose head could be a voting member.

¹⁶ The DFA provides a detailed framework governing the application of the power.

¹⁷ FSOC and its member agencies, taken together, have wide-ranging powers to take regulatory and macroprudential actions. The current structure and governance of U.S. financial regulatory agencies suggests that moving the balance of powers in favor of the Council—a solution used elsewhere with the aim of delivering a rapid response to emerging risks—may not be a straightforward option in the United States.

¹⁸ The principal structural changes were the abolition of the Office of Thrift Supervision (OTS) and creation of the Council, Consumer Financial Protection Bureau (CFPB), Office of Financial Research (OFR), and the Federal Insurance Office (FIO). Individual agencies were also granted additional responsibilities in some cases.

11. There are some ambiguities in the role and responsibilities of individual Council members and of FSOC member agencies. Section 102 of DFA defines member agencies as agencies represented by a voting member of the Council. Section 111 of DFA lists the voting members of FSOC as the individuals fulfilling particular roles, such as the Comptroller of the Currency, and the members are assigned responsibilities for decision making and for signing off on the FSOC Annual Report. Section 111 of DFA also lists the non-voting members of FSOC as individuals fulfilling particular roles, such as the Director of OFR and the Director of FIO. Alternative views have been expressed as to whether members of FSOC should participate in an individual capacity or on behalf of the agencies that they head. Since a clear objective of FSOC is to strengthen coordination among the regulatory agencies to promote U.S. financial stability it would be helpful to resolve this ambiguity.

12. A model where Council members act on behalf of the agencies they lead could offer stronger support for FSOC objectives and authority for FSOC work than one where the members act in an ex officio capacity. However, adoption of such an approach would require individual members to ensure the support of decision-making bodies within their agencies for key FSOC decisions. This would be complex given that some agencies' governance structures involve a commission, and policy decisions require a consensus or majority vote.

13. Provision of an explicit financial stability objective to member agencies would also bolster coordination. The common purpose would be further strengthened by providing an additional statement of clarification that the member agencies themselves support the work of FSOC in maintaining U.S. financial stability. The Council brings together the heads of all the main U.S. financial regulatory agencies and assigns the collective the task of identifying risks to financial stability and responding to threats. But at the same time, each member agency has an individual mandate and responsibility which has not been altered by the introduction of FSOC. The individual mandates do not typically include financial stability.¹⁹ As the duty of the agency is to meet the mandate provided by U.S. legislation and Congress, there is consequently no legal framework pulling the regulatory agencies together for a common purpose or objective. The lack of a formal mandate may complicate the role of their representatives on FSOC, and potentially undermines the agency response to FSOC recommendations. Providing an explicit financial stability mandate would give additional clarity on the role and duties of FSOC member agencies.²⁰ It is therefore important

¹⁹ The mission statement of the Federal Reserve is an exception and includes 'maintaining the stability of the financial system and containing systemic risk that may arise in financial markets.' The CFTC mission also refers to the role 'to protect market participants from fraud, manipulation, abusive practices, and systemic risk related to derivatives.' In addition, FIO has responsibility to identify issues or gaps in the regulation of insurers that could contribute to a systemic crisis in the insurance industry or the U.S. financial system.

²⁰ See IMF Staff Guidance Note on Macprudential Policy <http://www.imf.org/external/np/pp/eng/2014/110614.pdf>. Such a proposal has also been supported by external commentators such as Donald Kohn (formerly Deputy Chairman of the Board of Governors of the Federal Reserve and currently a member of the Bank of England Financial Policy Committee). Stanley Fischer (current Deputy Chairman of the Board of Governors, and also Chair of the recently established Federal Reserve Financial Stability Committee) has noted that: "It may well be that adding a

(continued)

that the mandate of the member agencies, as enshrined in the respective laws, be amended to include an explicit financial stability objective, with a view to supporting the FSOC work. As an immediate step, member agencies could also each voluntarily provide a clear statement that the agency fully supports the work of FSOC, subject to meeting the mission and objectives of the individual agency.

14. It is crucial that the FSOC’s political independence not only be maintained, but should be seen to be maintained.²¹ This issue has been raised in the U.S. context, given the strong role of the Treasury in the FSOC, and it is therefore crucial that the FSOC’s political independence not only be maintained, but should be seen to be maintained. The leadership and decision-making structure is relatively unusual by international standards. In particular, it is unusual for the finance ministry to play such a prominent role, as both the Chair of the Council, and in some cases—such as designation decisions—being assigned a ‘primus inter pares’ role, with a veto power.²² Common international practice is for the central bank to act as the chair of financial stability or macroprudential policy councils to help insulate the councils from short-term political pressure and facilitate taking tough decisions necessary to maintain financial stability. Some counterweight against such pressure is provided in the U.S. structure by the one person, one vote framework applying for many decisions. Counterweight is also provided by virtue of the duties and responsibilities of individual members set out in the DFA and by the depth and breadth of representation across the complex regulatory structure. Moreover, since the Treasury is not a supervisory agency, the Treasury Secretary’s role as Chair may facilitate cooperation amongst the various regulatory agencies in the Council.

15. The governance structure of the Deputies Committee and other FSOC staff Committees is also important in ensuring appropriate checks and balances. As well as Chairing the Council, the U.S. Treasury also serves as the Chair of the important Deputies Committee. And FSOC Secretariat staff, drawn almost entirely from the U.S. Treasury, facilitates the operation of the other FSOC staff Committees in the absence of appointed Chairs. Consideration should be given to appointing Chairs to the FSOC staff Committees, drawing on the expertise of member agencies as appropriate. Increasing the proportion of FSOC Secretariat staff on detail from member agencies would also be helpful and could increase the buy-in by member agencies.

financial stability mandate to the overall mandates of all financial regulatory bodies, and perhaps other changes that would give more authority to a reformed FSOC, would contribute to increasing financial and economic stability.”
<http://www.federalreserve.gov/newsevents/speech/fischer20140710a.htm>.

²¹ See for instance IMF Staff Discussion Note “Institutional Models for Macroprudential Policy”, November 2011.

²² A survey conducted by the IMF in 2013, revealed that out of 113 countries responding, only some 29 (26 percent) included an explicit role for the finance ministry in the collective institutional arrangements for macroprudential policy— typically alongside other bodies. That may be contrasted to the 110 (97 percent) of respondents where the central bank plays an explicit role (in 49 (43 percent) of cases alone). Among the 27 advanced economies responding, only 9 (33 percent) provide an explicit role for the finance ministry, in contrast to the 25 (92 percent) where the central bank plays an explicit role (in 10 cases (37 percent) alone).

Table 1. Organization, Role and Powers of FSOC and other Macroprudential Oversight Bodies

Characteristics	U.S. FSOC	UK FPC	European Systemic Risk Board (ESRB)
Summary Remit ¹	Identify threats to financial stability. Promote market discipline. Respond to emerging threats.	Identification, monitoring, and taking actions to remove or reduce systemic risk.	Macroprudential oversight, to contribute to the prevention of systemic risks in the EU, and to contribute to smooth running of the internal market.
Membership	10 Voting members, 5 nonvoting members ²	10 Voting members ³	38 Voting members ⁴
Chair	Treasury Secretary	Central Bank Governor	President ECB
Principal powers	Designation of systemic nonbanks and FMIs. Recommendations to regulatory agencies.	Recommendations to the FCA and other bodies. Powers of direction to deploy specified tools.	Recommendations for remedial action (in public and in confidence). Warnings (in public and in confidence to the EU Council).
Responsibility for specific policy tools	No	Yes	No
Power to give recommendations	Yes	Yes	Yes
Use of formal recommendation powers	Once (proposed)	On multiple occasions	On multiple occasions
Decision making	Voting (generally majority or 2/3)	Voting	Voting
Meeting frequency	Approximately monthly ⁵	Quarterly cycle of meetings	Quarterly meetings
Principal Communication tools	Annual report. Readouts and subsequent minutes of meetings.	Financial Stability Report (twice a year). Detailed minutes of meetings.	Annual report. Publication of a quarterly ESRB risk dashboard. Publication of recommendations.
Accountability provisions	U.S. Congress. Publication of an Annual Report. Members must individually sign off annually on the financial stability program.	U.K. Parliament. Decision must be explained, meeting minutes published and a Financial Stability Report published twice a year.	European Parliament. Publication of an Annual Report.

1/ This is a summary of the formal remits of each body.

2/ Voting members are the heads of regulatory agencies, together with an independent member with insurance expertise. (See Appendix 1).

3/ Members are the Governor of the Bank of England, the CEO of the Financial Conduct Authority, 3 Deputy Governors and an Executive Director of the Bank of England, and 4 senior external experts.

4/ Voting members are the President and the Vice-President of the European Central Bank (ECB), the Governors of the national central banks of the Member States, one Member of the European Commission, the Chairperson of the European Banking Authority (EBA), the Chairperson of the European Insurance and Occupational Pensions Authority (EIOPA), the Chairperson of the European Securities and Markets Authority (ESMA), the Chair and the two Vice-Chairs of the Advisory Scientific Committee (ASC) and the Chair of the Advisory Technical Committee (ATC). The ESRB Board also has non-voting members.
<https://www.esrb.europa.eu/about/orga/board/html/index.en.html>.

5/ FSOC must meet at least quarterly.

- *To underscore the independence of FSOC, it would be helpful to clarify the organization and governance arrangements for each of the Committees in the Charters that are under development, ensuring that the expertise of each of the member agencies is drawn on appropriately. Moreover, it would be helpful to appoint Chairs for each of the supporting staff Committees, drawing upon the expertise of the member agencies.*²³

16. Collaborative working and coordination across the FSOC member agencies in support of U.S. financial stability would be reinforced by implementation of the following recommendation:

- *The mandates and mission statements of each of the FSOC member agencies should be supplemented by addition of an explicit financial stability mandate. As an immediate step towards this goal, member agencies are encouraged to publish voluntary statements that the agency fully supports the work of the Council, subject to meeting the mandate and mission of the individual agency.*

C. Strengthening Systemic Risk Identification in the United States

17. A key initial task for FSOC has been to develop a robust framework for the identification of emerging threats to U.S. financial stability. Prior to the establishment of FSOC, no authority had the capacity or responsibility to undertake any monitoring or assessment of risks to the system as a whole. Regulators naturally focused on their individual mandates. Data collection and availability of information was itself piecemeal as a result of the fragmented regulatory structure. And no agency developed the necessary analytical tools to support the identification of disparate threats to financial stability in the United States.

18. Notwithstanding progress in improving information sources, systemic risk analysis in the United States is hampered by continued data gaps. Deficiencies in the availability and quality of financial information in advance of the global financial crisis severely affected the authorities' capacity to understand and analyze emerging financial stability risks and to plan and implement effective mitigation and crisis management measures. In recognition of the problems, the U.S. authorities have invested in a new structure (the OFR, structured as an Agency of the U.S. Treasury—see Appendix 2), which was created by DFA to support the work of the Council by improving financial data. The OFR works actively with the financial regulatory agencies and expert members to improve the quality and scope of financial data, including through the FSOC Data Committee and through bilateral contacts. Following production of a stock-taking inventory of data collections undertaken by the member agencies, the OFR and FSOC member agencies are now working to close identified gaps. Notwithstanding improvements in recent years, gaps remain substantial. Indeed, as recently highlighted by the OFR: *"Data available to regulators are not currently sufficient to evaluate many of the key risks and policy issues."*²⁴ Urgent priorities are to improve data on repo and

²³ Charters for each Committee were published in May 2015, but they do not provide for a Chairperson.

²⁴ OFR Annual Report 2014 page 105.

securities lending markets, on the asset management industry more generally and on other aspects of nonbank finance. Moreover, it would be very helpful to address the current data gaps on the connectedness between banks and the non-bank system, as well as on broader interconnections within the financial system.²⁵ The project to enhance the *Financial Accounts of the United States* recently announced by the FRB with the support of the OFR is very welcome.²⁶

19. Impediments remain to the effectiveness of data sharing arrangements among U.S. agencies. Data are collected by regulatory agencies under different legal and administrative arrangements. Given the importance of preserving the security of market sensitive information, the legal frameworks governing individual data collections sometimes place strong restrictions that inhibit the sharing of data, even with other regulatory agencies.²⁷ That creates a barrier to the utilization of existing data sources to pull together a picture of emerging risks for the system as a whole. To satisfy the FSOC statutory duty to facilitate information sharing, the FSOC agencies have developed procedures to enable sharing under the general approach that every agency maintains authority and control over their own data. While welcome, such procedures appear, however, to be cumbersome and relatively inflexible, requiring tailored application in each case. As a result, currently available data may not be used to their maximum effect. The ‘flash rally’ in the government securities market on October 15, 2014 provides an interesting example. Several regulatory agencies had information on different aspects of the market, and different actors; and one agency gave an initial report to the FSOC in early November—a rapid response. But in depth analysis required additional feedback from FSOC, and completing the legal access arrangements among the agencies took additional time. Separately, there was uncertainty as to whether some data could be shared, for example, with the U.S. Treasury debt management unit (an interested party, but not a regulatory agency). Summarizing the current position on data availability, FRB Governor Brainard recently noted that: “no U.S. agency yet has access to complete data regarding bank and nonbank financial activities.”²⁸ She emphasized the importance of the OFR making progress in: “facilitating the sharing of previously siloed data sets among the independent regulators.”²⁹

20. Improving the standardization of financial data remains an important priority. Data collections undertaken by different regulatory agencies are typically targeted and tailored to the policy question in hand. Such tailoring, however, leads to inconsistencies in data definitions and substantially lowers the ability of the authorities to aggregate different data sources and build an accurate picture of risks to the financial system as a whole. Moreover, a piecemeal approach to data

²⁵ The United States is one of the six FSB member jurisdictions that do not currently provide information on the interconnectedness between the banking sector and non-bank financial sector. <http://www.financialstabilityboard.org/2014/11/global-shadow-banking-monitoring-report-2014/>.

²⁶ <http://www.federalreserve.gov/econresdata/notes/feds-notes/2014/enhanced-financial-accounts-20140801.html>.

²⁷ For example, the 2014 FSOC Annual Report notes in respect of swaps data, that: “some U.S. authorities’ access to these data remains a challenge due to legal and other obstacles”.

²⁸ <http://www.federalreserve.gov/newsevents/speech/brainard20141203a.htm>.

²⁹ <http://www.federalreserve.gov/newsevents/speech/brainard20141203a.htm>.

collection adds to production costs.³⁰ The OFR is consequently actively promoting the greater standardization of data at a granular level, which would support flexible data aggregation and thus enhance financial stability analysis. For example, the OFR advocates widespread use of the Legal Entity Identifier (LEI)—a unique global identification system for parties to financial transactions developed by the FSB and endorsed by the G-20.³¹ Nevertheless, although the CFTC was the first adopter of the system within the global regulatory community—requiring use of the identifier for reporting derivatives transactions to swap data repositories—and the system was subsequently adopted by the NAIC³² and the SEC with respect to mandatory swaps reporting rules, take-up by other regulatory agencies in the United States has been relatively sluggish. A clear announcement from all member agencies that the LEI will provide the basis for future mandatory data collection that requires entity identification would provide a welcome boost to data standardization initiatives.

21. The FSOC risk assessment structure facilitates the collective review of concerns and emerging risks identified by individual member agencies. In particular, the FSOC Systemic Risk Committee (SRC) brings together staff from all member agencies to support the identification of threats to financial stability by the Council. Member agencies consequently have the opportunity to recommend issues for review and consideration as potential system-wide threats, enabling FSOC to draw on the collective analysis and experience of the U.S regulatory community. To support this work it is important that member agencies take a comprehensive and rigorous approach to risk assessment.³³

22. System-wide risk assessment must also look beyond the regulatory perimeter. As well as drawing on the insights and experience of regulatory agencies in identifying emerging risks within their areas of responsibility, it is essential to focus on the potential for risks to emerge beyond the regulatory frontier, including from the impact of regulatory arbitrage. FSOC has responsibility to identify risks to the system as a whole and thus to take account of risks building outside the combined regulatory perimeter; this is complemented by the OFR, which provides regular reports to FSOC committees on financial market developments and potential risks that may warrant further investigation. As individual regulatory agencies generally do not have the responsibility and thus incentive to undertake risk assessment beyond their statutory mandate, it would be helpful to spell out more clearly the collective framework and processes that FSOC has put in place to monitor and assess such risks and avoid gaps, including the assignment of responsibilities to member agencies and the OFR for risks that lie outside regulatory boundaries. While the FSOC and the independent OFR Annual Reports have included some risks from innovation and migration of intermediation

³⁰ For example, while the NAIC has initiated a collection of securities lending data from insurance companies, the FRB, SEC, and OFR are separately starting a pilot project on the collection of securities lending data, potentially with different data definitions.

³¹ http://www.financialstabilityboard.org/publications/#mt_page=14.

³² http://www.naic.org/Releases/2012_docs/naic_legal_entity_identifier.htm.

³³ The U.S. FSAP 2015 Detailed Assessment Report on conformance with the IOSCO principles on the regulation of securities markets notes the scope for enhancements to the monitoring of market risks.

beyond regulatory boundaries,³⁴ additional reassurance that FSOC is focusing broadly on threats to overall financial stability would be provided by inclusion of a specific, focused section within the FSOC Annual Report assessing risks beyond the regulatory frontier.³⁵ The current section reporting on areas the Council is monitoring is a helpful start.³⁶

23. Responsibilities for identifying risks from international developments and the spillovers and spillbacks from U.S. policy actions should be clarified. Given the strong interconnections between the U.S. financial system and global financial markets, it is important that FSOC closely monitors international financial developments and market risks. The FSOC Annual Report identifies risks from international markets as a threat to U.S. financial stability and describes the principal concerns and threats. It would be helpful to set out the responsibilities for monitoring such risks across the member agencies and the OFR on a continuing basis to avoid the possibility of any gaps. As developments and policies pursued by the U.S. regulatory authorities also have an important impact on other countries, and risks may spillback to the United States, it would also be helpful if FSOC provides a regular assessment of the potential impact of major U.S. policy developments on global financial market risks in the FSOC Annual Report.

24. FSOC member agencies have developed new analytical tools to monitor system-wide risks. The OFR has developed a Financial Stability Monitor, which provides a traffic-light summary of five categories of system-wide risk (macro, market, credit, funding/liquidity, and contagion) combining information from a wider range of indicators to signal financial stress.³⁷ And OFR staff is developing a suite of additional monitoring tools. Economists at the FRB are deepening monitoring frameworks to support the work of the recently established FRB Financial Stability Committee, which oversees internal FRB responsibilities for financial stability. Staff at other FSOC member agencies, such as the FDIC and the OCC has also introduced new monitoring tools and frameworks to support strengthened systemic risk monitoring and the agencies' contribution to FSOC risk discussions. It is important to continue the work to develop systemic monitoring tools to support a rigorous and systematic assessment of systemic risks by FSOC. Transparency of the risk assessment process would be enhanced by publication of a chapter in the 2016 FSOC Annual Report describing the procedures and principal monitoring tools and techniques adopted to support the process.

³⁴ See FSOC Annual Report 2014, and OFR Annual Reports for 2013 and 2014.

³⁵ Such a recommendation has been proposed by Donald Kohn <http://www.bankofengland.co.uk/publications/Pages/speeches/2014/726.aspx>. The U. S. Treasuries market, together with spillovers from this market to other parts of the financial sector, would be an obvious candidate for such monitoring by the FSOC.

³⁶ See section 7.2 of the 2014 FSOC Annual Report.

³⁷ OFR Annual Reports 2013 and 2014.

25. Current threats to U.S. financial stability are highlighted each year in the FSOC Annual Report. Nine areas are identified in the 2014 report for continued attention and possible action, as summarized below.^{38,39,40}

- 1) Short-term wholesale funding markets:** Regulatory agencies and market participants should continue to take action to reduce vulnerabilities in wholesale funding markets, including tri-party repo and MMMFs that can lead to destabilizing fire sales.
- 2) Housing market reform:** Regulators should continue to work with policymakers to implement the significant structural reforms needed to reduce taxpayers' exposure to risk in the housing market.
- 3) Operational risks:** Cybersecurity threats, infrastructure vulnerabilities, and other operational risks remain a top priority for the Council, and regulators should continue to take steps to improve financial institutions' ability to prevent operational failures and improve resiliency.
- 4) Developments in financial products, services, and business practices:** As the financial system evolves in response to technological, competitive, and regulatory changes, regulators should remain attentive to financial innovation and the migration of certain activities outside of traditional financial intermediaries that could create financial stability risks.
- 5) Reforms in reference rates:** U.S. regulators should continue to cooperate with foreign counterparts to address concerns about benchmark reference rates such as LIBOR.
- 6) Financial system vulnerability to interest rate volatility:** Regulators and institutions should remain vigilant in monitoring and assessing risks related to interest rate volatility, particularly as investors seek higher yields in a low interest rate environment.
- 7) Data gaps and data quality:** Financial regulatory agencies should continue to work with the OFR to fill financial data gaps and address related issues of data quality and comprehensiveness.
- 8) Risk-taking incentives of large, complex, financial institutions:** Regulators should continue implementation of DFA reforms to reduce risk-taking incentives of large, complex, interconnected financial institutions.

³⁸ Summary taken from remarks of Treasury Deputy Assistant Secretary (and Executive Director of FSOC), Patrick Pinschmidt, before the ABS East Conference September 2014: <http://www.treasury.gov/press-center/press-releases/Pages/jl2644.aspx>.

³⁹ These concerns encompass the four areas studied in greater depth in the following sections.

⁴⁰ The 2015 FSOC Annual Report published in May 2015 after the conclusion of the mission added two new topics that have received increased regulatory attention: changes in financial market structure, and central counterparties (CCPs).

- 9) **Foreign markets risks:** There is a need for continued monitoring of adverse financial developments abroad and their potential impact on the U.S. financial system.

26. Identified threats span a very broad spectrum of potential risks to the U.S. financial system and publishing a fuller assessment of the relative importance attached to each of the identified threats (such as their likelihood and impact) would be helpful. Although the areas outlined each warrant monitoring as part of the continuous assessment of financial stability risks, systemic risk oversight and follow up would be sharpened by provision of a clearer assessment of the relative importance attached by FSOC to each area of threat.⁴¹ Moreover, the areas highlighted vary in specificity and scale. Some are relatively tightly defined, such as addressing concerns about benchmark reference rates, e.g. LIBOR. But others are relative broad and generic, such as the need to remain attentive to financial innovation and migration of financial activity beyond the regulatory frontier. While avoiding the straitjacket and drawbacks of attempts at precise codifications, a clearer statement of the emphasis attached to each identified threat, and perhaps an indication of perceived likelihood and materiality, would nonetheless help to sharpen the focus, ownership and accountability of the collective risk oversight by FSOC member agencies, as well as providing additional guidance and clarity to follow up work, as outlined in the following section.⁴² FSOC clearly needs to retain the flexibility to respond to new developments, such as the October 15 Flash Rally. The credibility of the FSOC should be strengthened by publishing the Council's understanding of the cause(s) of the incident, its analysis, and proposals to address any systemic weaknesses identified—in particular those, such as interactions between liquidity, high-frequency trading and rapid price movements, that may have implications for other market sectors.⁴³

27. Systemic risk identification in the U.S. financial system has been significantly enhanced by the establishment of the FSOC. Specific recommendations to strengthen the framework are:

- *FSOC should set a clear short-term deadline to address outstanding obstacles to data sharing, and to agree a flexible, data sharing protocol across member agencies to support collective systemic risk oversight.*
- *FSOC should continue to direct the OFR to prioritize work to address data gaps in short-term wholesale funding markets, in nonbank financial intermediation (such as asset management) and in interconnectedness indicators across the financial system.*

⁴¹ For example, assigning different threats as high, medium, low likelihood, and high, medium or low impact, together with an explanation for the judgment. The assessment could also indicate an assessment of whether risks are increasing or decreasing. The OFR is developing analytical tools such as the Financial Stability Monitor which could provide useful input into the assessment by FSOC (See OFR Annual Reports for 2013 and 2014).

⁴² The GAO has supported such a recommendation. <http://www.gao.gov/assets/670/665851.pdf>.

⁴³ While recognizing the causes of this particular incident are not yet fully understood, it would be helpful for the FSOC to provide some public feedback at an early stage.

- *FSOC should publish additional information on the monitoring framework underpinning systemic risk identification and on the work of the SRC, to aid transparency and accountability. The monitoring framework should set out the responsibilities for monitoring risks beyond the regulatory perimeter and risks from global financial developments.*
- *FSOC should publish additional guidance in each Annual Report on the materiality the Council attaches to each of the identified threats to U.S. financial stability, including a judgment on their likelihood and impact.*

D. Addressing Identified Threats to Financial Stability

28. To ensure that systemic risks are addressed and thus financial stability is preserved, FSOC has responsibility for responding to emerging threats to financial stability—the third primary purpose set out in the DFA. The effectiveness of the response depends on the strength of the policy framework, including: the responsibilities and powers assigned to the authorities; the availability and development of appropriate policy tools; and the readiness and willingness to deploy them.

29. Primary responsibility for designing and applying prudential standards and macroprudential tools remains with the member agencies. FSOC is not a regulatory agency. FSOC has specified powers prescribed under the DFA, for example to designate nonbank companies for consolidated supervision by the FRB and heightened prudential standards. In this case, the higher standards are, however, set by the FRB, although FSOC may make recommendations to the FRB for consideration.⁴⁴ Similarly, the Council may provide for more stringent regulation of a particular activity by issuing recommendations to the primary regulatory agency to apply new or heightened standards and safeguards on a comply or explain basis.⁴⁵ Although a powerful backstop provision, even in this case the ultimate responsibility rests with the primary regulatory agency. This differs from experience in some countries where the authority most equivalent to FSOC has been assigned direct responsibilities for the deployment of certain macroprudential tools.⁴⁶

30. The key role of FSOC is to strengthen collective ownership of the actions needed to address identified risks and to promote, encourage and consider the actions taken by the member agencies. FSOC is the coordination agency rather than the decision making body in each case. But by bringing together the key decision makers under an overarching framework where they are charged to collaborate to respond to emerging financial threats, FSOC has the scope to play a powerful role. In particular, the Council provides a structure where members can explain the views and proposed actions of their individual member agencies and can coordinate to ensure that actions taken are consistent and effective and that there are no gaps. And although FSOC generally has no

⁴⁴ Section 115 of DFA.

⁴⁵ Section 120 of DFA.

⁴⁶ See, for example, Table 11 in the June 2014 report of the European Systemic Risk Board for a discussion of the arrangements in Europe: <https://www.esrb.europa.eu/pub/html/index.en.html>.

formal powers for decisions on regulatory rules and for the deployment of macroprudential tools, the Council may provide valuable guidance and advice to individual regulatory agencies, underpinned by the ability to make formal recommendations to regulatory agencies. Adopting a policy whereby members agree to formalize the consultation of FSOC as standard practice during the consultation process on major new regulatory rules that could impact financial stability⁴⁷ and on the potential new application of macroprudential tools (or tools with a macroprudential impact)⁴⁸ would further strengthen the collaborative framework and consistency of approach, while respecting the current responsibilities of member agencies.

31. Clarifying and publishing the agreed assignment of objectives, responsibilities and timelines for follow up of identified threats would strengthen the effectiveness of risk reduction policies. As noted above, the FSOC Annual Report provides a relatively detailed survey of identified threats to financial stability. And the Council publishes recommendations of policy actions to address the risks. Such recommendations are helpful. But, as highlighted by the GAO,⁴⁹ the current public recommendations often lack specificity and sharpness in respect of the actions expected to be taken, the agency or agencies responsible for implementation, and the expected timeline for delivery.⁵⁰ Although the FSOC Secretariat maintains an internal monitoring system, there is no clear public process for tracking the risks or for ensuring follow up. However, FSOC Annual Reports include a description of whether progress has been made since the previous Annual Report, and FSOC minutes and webcasts of open meetings describe follow-up work on a number of the recommendations. While recognizing the need to retain flexibility and to strive for ambitious objectives that may sometimes be difficult to attain, the force and impact of the policy recommendations would be strengthened by sharpening the specificity and focus of the actions FSOC recommends to address each identified priority threat, by stating clearly which agency is (or agencies in collaboration are) responsible to deliver them, and by clear specification of the expected timeline for implementation and reporting of the results to guard against slippage and delay. The recommendations should be published in the FSOC Annual Report and followed up in the subsequent meeting minutes and Annual Report.

32. Actions are continuing to strengthen the macroprudential policy framework and toolkit to address emerging systemic threats. In general, macroprudential policy pursues three interlocking objectives: to increase the resilience of the system to aggregate shocks by building additional buffers; to address structural vulnerabilities or points of weakness in the financial system,

⁴⁷ Some proposed rules have been presented to FSOC for consultation in advance of finalization, for example the Federal Reserve Foreign Banking Organization (FBO) rule and the CFPB QM rule. In addition, outside of FSOC, member agencies have coordinated on key rulemakings including the Volcker rule, risk retention rule, and OTC derivatives rule, as well as capital, liquidity and bank stress testing requirements.

⁴⁸ The QM is not a macroprudential tool, but has a macroprudential read-across.

⁴⁹ See <http://www.gao.gov/assets/650/648064.pdf> and <http://www.gao.gov/assets/670/665851.pdf>.

⁵⁰ In a review published in September 2014, the GAO stated that the office “maintains that action is needed as its past work has shown that the lack of clear roles and coordination can lead to duplication, confusion, and regulatory gaps.” <http://www.gao.gov/assets/670/665851.pdf>.

arising from interlinkages and the critical role of certain financial institutions or infrastructure; and to contain the systemic vulnerabilities arising from procyclical links between credit provision and asset prices, and from the buildup of leverage and funding weaknesses.⁵¹ Policy tools to support these goals are typically separated into two broad categories: 1) structural measures which address points of weakness and focus on building additional resilience and buttresses against a range of potential shocks; and 2) counter-cyclical measures which act to limit the cyclical buildup of systemic risks. A summary of the main tools in place, under preparation, and under review in the United States is provided in Appendix 3.

33. The United States is making good progress to raise the structural resilience of the banking system to weather shocks. As set out in the DFA, the U.S. authorities are introducing stronger prudential standards as well as more intense supervision for large, banking institutions, to address the greater risks that they pose to the overall financial system.⁵² In particular, the largest banks will be subject to additional capital requirements, enhanced leverage and liquidity standards, and additional restrictions on single counterparty exposure limits. The rules build on international standards but in many cases have been reinforced⁵³—for example, under a notice of proposed rulemaking provided for comment in December 2014, the implementation of additional capital surcharges for the 8 largest U.S. globally systemic banks (G-SIBs) will be altered to include a specific element for short-term wholesale funding risks,⁵⁴ and under rules set out in 2014, the supplementary leverage ratio and liquidity standards for G-SIBs have been enhanced above the Basel III standard. Large banking organizations must also participate in regular, intense stress testing exercises, both in relation to capital and liquidity,⁵⁵ which are applied ‘macroprudentially’ to take specific account of size and connectedness across the system, and to assess the preparedness of firms to address potential systemic risks.⁵⁶ And large BHCs must also prepare resolution plans for scrutiny by the FRB and FDIC.

34. The United States’ ability to assess systemic risk related to designated FMUs, ensure consistent application of international risk management standards across the designated FMUs, and coordinate policy actions has improved substantially. The DFA entails major

⁵¹ See IMF ‘Key aspects of macroprudential policy’ June 2013.

⁵² The U.S. framework categorizes banks according to size (such as assets >\$10bn; >\$50bn; >250bn or >\$10bn in foreign assets). In addition, a category of global systemically important banks (G-SIBs) is proposed by the FRB based on methods drawing on indicators of size, interconnectedness, cross-jurisdictional activity, complexity, substitutability and use of short-term funding. Under the proposed methodology, 8 large U.S. bank holding companies would currently be identified as G-SIBs. Regulatory standards toughen as size grows.

⁵³ In some cases the rules are at the proposal stage. The stronger regulatory standards will be phased in over the next 2-3 years.

⁵⁴ The proposed framework for capital surcharges would be phased in from January 2016 to the end of 2018, being fully effective from January 2019. <http://www.federalreserve.gov/newsevents/press/bcreg/20141209a.htm>.

⁵⁵ The Dodd-Frank stress tests, the Comprehensive Capital Assessment Review (CCAR) and the Comprehensive Liquidity Assessment Review (CLAR) <http://www.federalreserve.gov/newsevents/speech/tarullo20140508a.htm>.

⁵⁶ See the companion Technical Note on Stress Testing.

improvements that should help to reduce systemic risks related to U.S. FMIs. In addition to providing FSOC with the responsibility to designate systemically important FMUs that have to comply with enhanced risk management standards prescribed by the FRB, SEC or CFTC, as applicable, the DFA also significantly improves cooperation among domestic supervisory agencies. It expands the FRB's role, in coordination with the CFTC and the SEC, in supervision, examination, and rule review, establishing a more consistent framework across supervisory authorities (see section below).

35. Progress on developing stronger standards for systemic nonbank financial institutions (NBFIs) remains work in progress.

As noted above, the FSOC has responsibility and powers to designate NBFIs for consolidated supervision by the FRB and the application of higher prudential standards. The Council has published detailed information on the process, procedures and criteria adopted for the rules underpinning the systemic designation of nonbank financial companies and for financial market utilities, as well as the assessments of individual cases.^{57,58} Three rounds of public consultation were held in advance of the publication of the final rule on systemic designation for NBFIs.⁵⁹ Four NBFIs have been designated so far (AIG, GE Capital and Prudential Financial in 2013 and MetLife in 2014).^{60,61} Designated nonbanks will be subject to enhanced prudential requirements, as well as to intense stress tests. The Federal Reserve is currently developing proposals for review and consultation—FSOC will review the proposals to judge whether it wishes to make a recommendation to the FRB.

⁵⁷ The DFA requires the Council to assess ten considerations when evaluating NBFIs. FSOC has grouped these into a six category framework—three elements which support the Council's assessment of the potential impact of a company's financial distress on the broader economy (size, substitutability, and interconnectedness), and three that support the Council's assessment of a company's vulnerability to financial distress (leverage, liquidity risk and maturity mismatch, and existing regulatory authority). FSOC has defined and published quantitative criteria to identify companies for evaluation under the procedure, as the first in a three-stage process for the assessment. At the end of step 3, FSOC may propose a determination (based on a two-thirds majority of voting members, including an affirmative vote by the Chair) and provide that to the company in writing. The company may request a hearing to contest the determination. For a final determination, the Council must then vote again subject to the same threshold.

⁵⁸ The first step of the three-stage process identifies candidates for possible designation for deeper review. The second stage provides an initial assessment. The third stage is a detailed in-depth review to support a determination. Given the timelines involved, it is important to proceed expeditiously with each case, to resolve uncertainty and support rapid decisions under stressed conditions in particular.

⁵⁹ FSOC announced changes in the designation process in February 2015 to increase transparency to the general public and to strengthen engagement with companies under consideration for designation. This addressed a number of previous GAO recommendations encouraging FSOC to publish additional material to support the designation process. The GAO has also recommended that FSOC sets out the framework that it will apply to assess the impact of the designation process, which is required every 5 years (the first study is due by January 2016). <http://www.treasury.gov/initiatives/fsoc/designations/Documents/Supplemental%20Procedures%20Related%20to%20Nonbank%20Financial%20Company%20Determinations%20-%20February%202015.pdf>.

⁶⁰ MetLife has recently applied to the U.S. courts contesting the designation decision.

⁶¹ The cases are reviewed annually—the designations of AIG, GE Capital, and Prudential Financial were not rescinded based on the 2014 review.

36. Stronger prudential standards for systemically important banks and nonbanks will increase the resilience of the U.S financial system. And together with the application of a robust resolution regime,⁶² the stronger standards will help to promote market discipline and lower moral hazard, the second primary purpose of FSOC. Although they promote resilience of key institutions against a wide range of shocks, the measures are not designed to address risks to the system from a concentrated buildup in sectoral exposures, such as to the housing market or commercial real estate, or from rapid credit growth, or from the potential for herding behavior in particular financial markets that can precipitate fire sales and a sudden evaporation of market liquidity.

37. The United States currently has a relatively limited set of “time varying” tools to address a build-up of cyclical and sectoral pressures on financial stability. To implement the agreed international standard, the FRB, OCC, and FDIC have introduced rules to implement a countercyclical capital buffer for the largest banks in the U.S system.⁶³ Triggers and standards for implementation of the tool are under design, but are not yet in place, however. Moreover, currently, the United States has few additional tools to contain a cyclical build-up of risk.⁶⁴ This is a deficiency in the current framework which is important for FSOC member agencies to remedy. For example, the United States does not have the flexible tools that have been applied in other jurisdictions to address a build-up of risks in housing markets or property markets, such as loan to value ratios or debt to income ratios.^{65,66} And while tools such as increases in sectoral risk weights on mortgage market exposures or on other areas of identified risk could be applied in principle either directly by regulators or indirectly through stress testing, such instruments would be slow to implement (requiring perhaps upward of a year to adjust) and may not be particularly effective.⁶⁷ Moreover, they would apply only to banks rather than to overall credit intermediation. CFPB rules apply to the market as a whole, but the CFPB does not currently have a financial stability mandate that would allow for a macroprudential usage. Similarly, FHA guarantees could, in principle, be structured for macroprudential purposes. (A review of housing finance risks and issues is contained in the final section of this note).

⁶² See companion note for assessment review of the U.S. resolution framework against the FSB Key Attributes for Resolution Regimes.

⁶³ The buffer applies only to firms with assets >\$250 bn or >\$10bn in foreign assets. The framework will be phased in over the 2016 to 2019 period. One year notification of application is required in normal circumstances (there is provision for agencies to require faster implementation if required).

⁶⁴ See the OFR 2014 Annual Report and speech by FRB Governor Brainard.
<http://www.federalreserve.gov/newsevents/speech/brainard20141203a.htm>.

⁷⁸ The criteria for Qualifying Residential Mortgages (QRM) governing risk retention requirements in respect of securitization agreed by 6 regulatory agencies (Federal Reserve, OCC, FDIC, FHFA, SEC and HUD) aligns the QRM standard with that for Qualifying Mortgages (QM) set by the CFPB to meet consumer protection goals. The QRM standards will be reviewed after 5 years (or earlier at the request of one of the agencies). The CFPB QM standard includes a requirement that debt service to income ratios must be 43 percent or less. There is no current plan or intention to use the QM or QRM instruments as potential time-varying counter-cyclical macroprudential tools.

⁶⁶ Banking agencies’ residential real estate standards do establish supervisory LTV limits for commercial and construction loans, but these do not vary in the light of response to the credit cycle.

⁶⁷ <http://www.federalreserve.gov/newsevents/speech/brainard20141203a.htm>.

38. Developing additional tools to strengthen market resilience should be a continuing high priority. The U.S. financial system is heavily dependent on capital markets and on nonbank intermediation. Notwithstanding the very welcome measures to strengthen the banking system, the authorities recognize the importance of additional policy actions to improve the monitoring and containment of risks arising in the ‘shadow banking’ (or market-based) financing system, and to address weaknesses in market financing structures that give rise to systemic liquidity risks. As highlighted in the OFR 2014 Annual Report: *“although supervisors have firm-specific tools...they have few system-wide tools to address market and credit excesses.”* In recent years, as outlined in the subsequent sections, policy actions have been taken to reduce vulnerabilities in triparty repo markets and to agree and finalize new regulations for MMMFs following the proposed recommendation from FSOC. Further work is underway to reconsider minimum margin requirements on secured credit,⁶⁸ potentially extending beyond the international proposals currently under consultation to introduce minimum margin requirements for non-centrally cleared securities financing transactions.⁶⁹ Detailed reviews of systemic liquidity risks and of risks in market-based financing together with recommendations to address them are contained in the following sections of this note.

39. In sum, the U.S. authorities have made significant advances in developing new tools and implementing an improved framework for addressing identified threats to financial stability. But some gaps remain in the toolkit and readiness to deploy macroprudential policies. The following recommendations are put forward:

- *For each identified material threat to financial stability highlighted in the Annual Report, FSOC should publish specific follow up actions to address each identified priority threat, stating clearly where responsibility for delivery of the actions lies, and specifying an agreed timeline for implementation and reporting of the results.*
- *To strengthen coordination and collective ownership of the risk mitigation actions, members should consult FSOC as standard practice on the development and implementation of major new regulatory rules that could impact financial stability.*
- *At a point in the conjuncture where financial stability risks appear to be building, FSOC and its member agencies should prioritize the development of the U.S. macroprudential toolkit, focusing particularly on developing new time-varying measures to address the buildup of cyclical and sectoral risks and to strengthen the resilience of financial markets to run risks and fire sales.*
- *FSOC and its member agencies should ensure that the instruments are ready to use, and that the appropriate legal authorities are in place. Members should consult FSOC as standard practice on the potential new application of macroprudential tools.*

⁶⁸ <http://www.federalreserve.gov/newsevents/speech/tarullo20131122a.htm> and <http://www.federalreserve.gov/newsevents/speech/tarullo20150130a.htm> .

⁶⁹ http://www.financialstabilityboard.org/2014/10/pr_141013/.

- *To provide clarity on the toolkit and on the readiness to deploy the instruments (as well as identifying remaining gaps), FSOC is encouraged to publish a summary of the U.S. toolkit identifying which tools are available to address particular types of risk and which agency/agencies have responsibility to deploy them, including the definition of triggers and the framework/approach to implementation. Updates should be published periodically as the toolkit is enhanced.*

E. Systemic Risks—A Closer Look at Some Key Concerns

40. An evaporation of market liquidity was a key amplifier and transmission channel in the global financial crisis, as highlighted in the previous FSAP. The mission consequently reviewed several key elements linked to liquidity provision in greater depth; namely the infrastructures and markets that channel liquidity and funds through the financial system, together with the U.S. system of housing finance that was one of the focal points of the crisis. The assessment below covers in turn: systemic liquidity and liquidity backstops; market-based finance; financial market infrastructure; and housing finance.⁷⁰

SYSTEMIC LIQUIDITY AND LIQUIDITY BACKSTOPS

A. Introduction

41. Freezing of liquidity was a key trigger for the crisis. Liquidity that is traded freely between banks and between key non-bank financial institutions is the cornerstone of a well-functioning financial sector. During the crisis, uncertainty about the financial health of counterparties led to a sharp drop in fed funds volumes traded and a significant widening in the OIS-LIBOR spread (a measure of bank credit risk). Non-bank activity also suffered as BDs at times had difficulty transacting even in the safest form of repos (backed by U.S. Treasuries).

42. Progress has been made in addressing these fault-lines though vulnerabilities may be masked by extraordinary liquidity conditions in the context of Quantitative Easing (QE). Although volumes in the fed funds market remain low, that is because of the substantially-increased reserve balances held by banks as a consequence of QE. Bank balance sheet repair, including more capital and liquidity, has helped address vulnerabilities, although it is hard to be sure how the interbank markets will function post-exit from QE or in another crisis. Repo markets too have recovered though activity remains lower than pre-crisis.

43. A focal point of liquidity stress was the tri-party repo market where deficiencies were identified in the operations, and in the regulation of some major participants (Appendix 4). BDs, the main borrowers through the tri-party repo market, were unable to obtain funding, there was a run on MMMFs, significant losses were incurred in a number of securities-lending cash

⁷⁰ See IMF Global Financial Stability Reports: April 2015 and October 2014 for additional discussion of the risks to the global financial system.

collateral reinvestments and the tri-party operational architecture was recognized as posing large risks through the massive intra-day exposures being run at the two clearing banks.

44. Flexible measures put into place quickly ameliorated liquidity strains, while some underlying features of the financial sector architecture also helped. A wide variety of programs were offered, targeted at different market segments and in some cases to overcome perceived stigma attached to use of the discount window. Further, a unique feature of the U.S. financial architecture—the Federal Home Loan Banks (FHLBs)—eased liquidity strains because the member banks were able to increase borrowing from the FHLBs by some \$500 billion during the early part of the crisis at rates lower than those available from the Fed’s discount window and without any accompanying stigma. The FHLBs are able to tap funding markets during times of stress largely because of their status as GSEs, which carries with it the perception by market participants of implicit support from the U.S. Government.

45. Considerable progress has been made in a number of areas. Reform of MMMFs has reduced the systemic risks posed by this sector, BD risks are better contained and the revised tri-party operational architecture has all but eliminated intra-day credit exposures. This section looks more closely at this progress and further steps that could be taken to address systemic liquidity vulnerabilities.

B. Tri-party Repo Infrastructure

46. A major achievement is the reduction in intra-day credit provided by the clearing banks. With the Federal Reserve Bank of New York (FRBNY) having taken the lead, the tri-party repo reform process has addressed the major risk identified during the crisis: intra-day credit extended by clearing banks has fallen from 100 percent of the repo activity down to less than five percent (Figure 1).⁷¹ This reduction was achieved by reengineering the settlement cycle and improving the collateral allocation processes. By end-March 2015 the clearing banks met the set objective of limiting intra-day credit to a maximum of 10 percent of a dealer’s notional tri-party book, through pre-committed lines (which incur a capital charge). One final piece of the reform process, integration of the General Collateral Financing (GCF) segment (for inter-dealer activity), is however yet to be completed.⁷²

47. Firesale risk was highlighted as a major concern by the FRBNY. Pre-default risks have been reduced through the regulatory impacts on MMMFs and BDs. Post-default firesale risks remain but may be manageable because systemically important BDs designated at the time of failure (DFA Title II) could come under the FDIC’s Orderly Liquidation Authority. Other BDs may be subject to the

⁷¹ A Taskforce on Tri-Party Repo Infrastructure was formed in 2009. This private sector body, sponsored by the FRBNY, produced its final report in February 2012. The Fed then took direct oversight over implementation of the reforms highlighting three areas of concern; excessive intra-day risks to the clearing banks, weak liquidity and credit management practices, and lack of planning for the orderly liquidation of a defaulted dealer’s collateral (i.e., firesale risks).

⁷² The total amount of GCF repo net cash settled on March 10, 2015 was \$130 billion compared to the tri-party repo market of \$1.6 trillion.

Securities Investor Protection Act (SIPA) which allows for a stay of four to five days for repos, but the interactions between the DFA and SIPA are complex, with uncertain implications.

48. The tri-party repo market relies on two clearing banks while alternative private sector models are being considered. Failure of either clearer would have a major impact of U.S. financial markets and measures should be considered to reduce this reliance. Some private sector initiatives involving the use of CCPs are under development and might have benefits including risk reduction through netting, improved risk management with a transparent risk waterfall, and with a centralized liquidation processing in the event of participant default. Nevertheless, the benefits of any such scheme would be limited if ultimately the transactions are settled through the same clearing banks as are currently used in the tri-party repo market.

- *An important next step to reducing the risks around tri-party repo is to reduce reliance on the two clearing banks, for example by developing options that might allow settlement in central bank funds.*

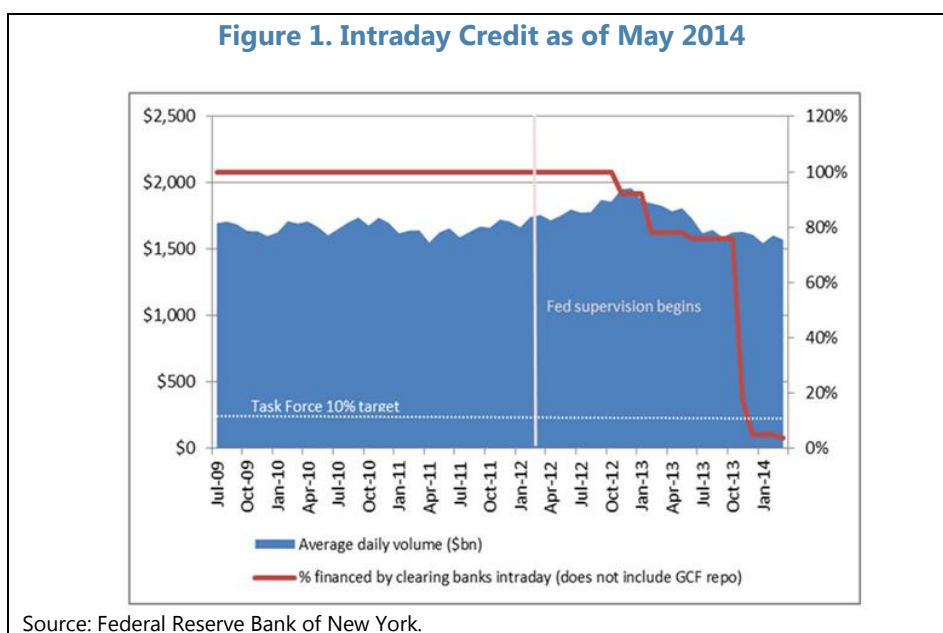

C. Repo Safe Harbors

49. Just prior to the financial crisis, 'safe harbor' for repo collateral was significantly expanded. Privileges accorded to cash lenders in repo transactions that allow immediate possession and sale of securities in the event of borrower default provide a safe harbor from bankruptcy proceedings. The securities afforded safe harbor in such transactions were expanded in 2005 to include mortgage loans, mortgage-related securities, interests in mortgage-related securities and mortgage loans and qualified foreign securities. This move pre-dated a major crisis with mortgage-related securities and repos at its center, by around three years. While numerous factors that

contributed to the severity of the crisis have been addressed, the consequences of the 2005 expansion of the safe harbor provisions should be assessed.⁷³ The intermediation and liquidity benefits of such a move may be outweighed by the increased risks to financial stability—arising from the increased use of relatively illiquid collateral and higher levels of balance sheet encumbrance. If a wider pool of repo collateral is to maintain safe harbor status, it is important that structures are put in place to mitigate the increased risks of operating with weaker collateral.

- *The authorities are encouraged to consider reviewing the financial stability impact of allowing mortgage-backed securities and other illiquid loans and securities safe harbor from bankruptcy proceedings.*

D. Broker-dealers

50. Many BDs—important users of tri-party repo funding—now operate within BHC structures subject to enhanced prudential regulation, thereby reducing vulnerabilities in the tri-party repo market. Leading up to the crisis many large BDs were outside of BHC structures and, more generally, securities intermediaries including affiliates of large banking organizations displayed lax credit and liquidity risk management practices and utilized excessive leverage. During the crisis some incurred substantial losses and faced major funding difficulties. Motivated by a desire to bolster market confidence in them and with industry consolidation resulting from the financial crisis, essentially all the largest independent securities firms reorganized themselves as BHCs or were acquired by BHCs during the crisis. The post-crisis regulatory response, with strengthened liquidity regulation (the liquidity coverage ratio) and supervisory standards, has markedly improved liquidity risk management practices of borrowers. The degree of maturity transformation has reduced, with tri-party repo books termed out. Systemic liquidity risks are therefore reduced, in large part because much short-term financing activity is now contained within the much-tightened regulatory framework where newly-strengthened capital and liquidity standards apply.⁷⁴

51. The regulatory framework at the BD level has not been adequately addressed, leaving some risk of regulatory arbitrage in the future. The moves by BDs to operate within BHC structures were voluntary, and conceivably entities not regulated as BHCs could again increase their liquidity and maturity transformation activities to pose a systemic risk.⁷⁵ Regulation at the BHC level, while already having had a clear impact, is no substitute for appropriate regulation at the BD level.

⁷³ Since in the event of default, safe harbor permits the cash provider to sell the asset immediately, rather than being caught by a bankruptcy stay, in a time of market stress the securities could be dumped on the market (asset fire-sales), exacerbating market stress.

⁷⁴ Basel III capital rules, LCR and recent FRB proposal on capital charge on STF.

⁷⁵ This is perhaps a small risk at this juncture given heightened counterparty scrutiny and with the prospect of FSOC designation should an entity grow to be of sufficient size and importance.

The SEC is considering new rules on capital, liquidity and leverage, yet seven years on from the crisis little has changed in this area.⁷⁶

- *Completion of the review of regulation at the BD level is a priority. The SEC should move to finalize and implement rule changes to contain risk taking thereby reducing the prospect of regulatory arbitrage in the future.*

E. Money Market Mutual Funds

52. **MMMFs—important providers of funding to the tri-party repo market, issue money-like investment shares, undertaking liquidity and maturity transformation (a ‘bank-like’ activity) while not being subjected to reserve requirements and deposit insurance levies.**⁷⁷

During the crisis this sector suffered a run, with the Treasury responding by providing a credit guarantee.⁷⁸ The Fed also instituted several liquidity facilities intended to help stabilize the sector. Changes to the law may mean, however, that a similarly speedy response to stress would be considerably more difficult in the future. Pending implementation of the SEC’s 2014 rule amendments, all MMMFs enjoy regulatory features that allow amortized cost accounting treatment and stable net asset values (NAVs) for reporting and redemption—a practice that supports the appearance of money-like liabilities while simplifying the tax treatment for investors. Assets under management (AuM) have stabilized at around \$2.7 trillion although when measured as a percentage of depository institutions’ deposits, they have declined from a peak of 43 percent in 2008 to 22 percent at the end of 2014 (Figure 2).

53. Several changes were introduced in 2010 to reduce systemic risks. Liquidity rules implemented in 2010 were calibrated at a level that the SEC estimate would have been sufficient to meet approximately 90 percent of redemptions in retail and institutional funds during the week of the greatest redemption pressure during the crisis. These rules now require funds to hold 10 percent of the portfolio in overnight cash and U.S. Treasuries, with 30 percent maturing within five days. A maximum of five percent can be held in illiquid securities and the maximum weighted average maturity of the portfolio is 60 days. Credit quality standards were also tightened, requiring the fund to ascertain the creditworthiness of the repo counterparty—previously the collateral had to be highly rated with no requirement with respect to the creditworthiness of the counterparty when the MMMF looked to the issuer of collateral to meet credit quality standards.⁷⁹ Funds must also perform

⁷⁶ The SEC is reviewing capital, liquidity and leverage rules with three specific provisions under consideration: 1) a minimum capital requirement of \$5 billion, 2) a requirement that liquidity rules be met at the broker-dealer level, and 3) a maximum leverage ratio for broker-dealers.

⁷⁷ The SEC’s rule 2a-7 under the Investment Company Act 1940 defines the criteria that funds must meet to qualify as money market mutual funds.

⁷⁸ The Treasury guaranteed the whole \$3.3 trillion market and a series of liquidity facilities were subsequently introduced by the Fed.

⁷⁹ Reportedly much of the tri-party repo business was conducted on the basis of the creditworthiness of the counterparty since MMMFs were undertaking repos with collateral that they could not hold outright if the counterparty defaulted.

regular stress tests to ascertain their ability to maintain a stable \$1 NAV in the event of changes in interest rates and credit spreads, defaults, and redemptions.

54. MMMFs are able to collateralize repos with securities that they cannot own outright.

Funds are allowed to ‘look through’ repo collateral providing they evaluate the creditworthiness of the counterparty. MMMFs could be in breach of SEC rules—notably those governing maturity of assets—where they take possession of the collateral after a counterparty failure, perhaps leading to forced sales and broader market disruption. General ex ante guidance on how funds should act, should such an event occur, has not been published.

- *The authorities should consider reducing the risks of forced sales by restricting the repo collateral to securities that the MMMFs are able to hold outright.⁸⁰*

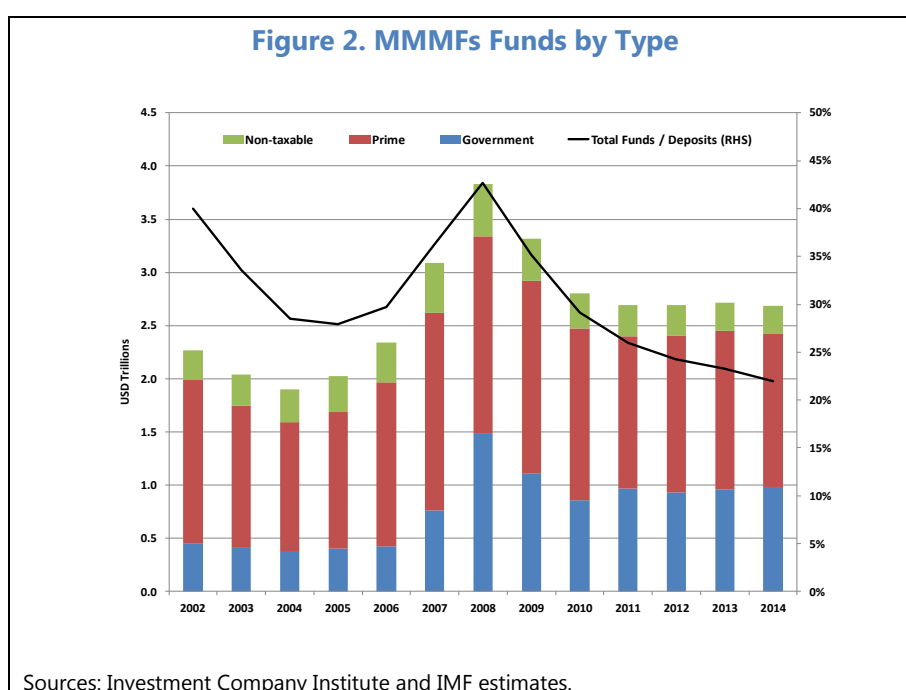

55. The SEC will implement new rules in 2016 requiring some funds to move to variable NAVs. Funds will be classified as: 1) government funds—if at least 99.5 percent of the assets are in ‘cash’ and treasury securities, 2) retail funds—where beneficial ownership is limited to natural persons, or 3) institutional funds—all other funds. While the first two categories can continue to use constant NAVs, institutional funds will be required to move to a variable NAV. The SEC is able to determine the definition of ‘cash equivalent’ under GAAP and they have continued to include all MMMFs, including those that will move to a variable NAV, within the ‘cash equivalent’ definition.

⁸⁰ U.S. Treasury securities form the bulk of the collateral taken by MMMFs. While there is no credit risk, there could be substantial interest rate risk. For instance, a sharp increase in term yields could bring down a leveraged broker-dealer and leave MMMFs owning 30 year bonds whose value had fallen by 10–20 percent, and that they would have to sell immediately.

Importantly, the reforms will also require private liquidity funds that operate like MMMFs to report monthly, thereby allowing for close monitoring of activities moving outside of the regulatory perimeter.

56. Other changes to come into effect in 2016 give all MMMFs the ability to impose fees and gates in a stress event. For all funds except Government funds, redemption fees of up to 2 percent *will be allowed* if the weekly liquid assets fall below 30 percent. Where weekly liquid assets fall below 10 percent, a fee of at least one percent is *mandatory*.⁸¹ Redemptions can be suspended (i.e., gated) where the weekly liquid assets fall below 30 percent. The gate must be lifted within 10 days and cannot be used for more than 10 days in a 90-day period. The existence of redemption gates may however lead to damaging pre-emptive runs. When investors perceive an increased risk of the MMMF becoming illiquid, they are likely to try to run before the gates are imposed. Further, a fund seeking to maximize value for its own investors would likely not consider the externalities of imposing gates, and once it had imposed gates, contagion to other MMMFs is possible given the similarity of portfolios across the industry.⁸² Government funds are not covered by these provisions but may include the use of redemption fees and gates provided such use is properly disclosed in the prospectus.

57. Given the three newly established categories of MMMFs, it is not clear what proportion of the current funds under management would fall into each category, but what is clear is that fund managers will modify their product suite in response to the new regulations. The Investment Company Institute estimated that less than a quarter of funds would be required to move to a variable NAV. But seemingly more important than the NAV is the potential imposition of gates and fees. Some managers provide sweep arrangements into MMMFs where the potential use of gates is inconsistent with investors' primary objective which is liquidity. A leading fund manager has already announced a repositioning of its funds in favor of Government MMMFs so that it can continue to offer a product that is free from redemption restrictions. Industry sources suggested that there could be a sizeable shift towards Government funds in the lead up to the implementation of the new rules. Such a shift is unlikely to be disruptive given recent publicity about the changes and in an environment of still abundant liquidity. However longer-term, the structural shift away from credit product will mean that private sector borrowers will likely have to pay relatively more for funds as compared to the Government at a time when other regulatory initiatives (e.g., LCR) have also increased the demand for high quality liquid assets. The impact could also be felt beyond the United States given that MMMFs have in the past been buyers of commercial paper issued by foreign banks (notably from Europe and Australasia).

58. While progress has been made, the fundamental flaws in MMMFs have not been addressed: a key element in addressing this should be the imposition of variable NAVs. The

⁸¹ An exception is possible if the directors believe that such a fee is not in the best interest of the fund.

⁸² The FRBNY (Staff Report April 2014: Gates, Fees and Preemptive Runs) assessed the impact of gates and concluded that they could cause a pre-emptive run from funds; SEC Commissioner Aguilar (Public Statement July 23, 2014) rejected the conclusion.

recent reform proposals by the U.S. authorities considered two tacks—to regulate them more like banks (with a capital buffer), or more like traditional mutual funds (with a variable NAV)—yet the government and retail funds have neither a capital buffer nor a variable NAV. And while retail funds can impose fees and gates during times of stress, Government funds—which it seems will account for a significant portion of total MMMFs assets—have neither a variable NAV nor any mechanism to manage redemption pressures during periods of stress. Although risks with Government MMMFs are low, recent history provides an example how even this seemingly safest of all short-term assets could give rise to redemption pressures. For example, in October 2013 as debt ceiling negotiations were prolonged there was a real prospect that some Treasury securities were not going to be redeemed on their due dates. With investors treating their units in the funds as money-like liabilities, together with a commitment to a constant NAV and with no mechanism to manage redemption risks, the scene could again be set for an investor run, albeit under quite different circumstances than in 2008.

- *Variable NAVs should be applied to all MMMFs thereby aligning the treatment with other open-ended mutual funds.*
- *FSOC could consider promoting commonly-agreed definitions of 'cash' and 'cash equivalent,' and metrics for judging the liquidity of assets.⁸³*

F. Fed Exit and Financial Stability

59. The Fed has ended QE and has signaled a tightening in monetary conditions in 2015 (Box 2). To ensure control over monetary conditions in the tightening phase the Fed has introduced new instruments and expanded its eligible counterparts much beyond its traditionally short list of primary dealers to include banks, MMMFs and certain GSEs. Potentially this approach increases financial stability risks, especially where the supply of safe assets is unconstrained and is offered at a fixed interest rate (i.e., a fixed-rate full-allotment mechanism). The risks arise because the MMMF segment is a major cash-provider in short-term funding markets and a sudden shift in investment by these institutions into the Fed's Overnight Reverse Repo (ONRRP) instrument could exacerbate liquidity pressures for their traditional borrowers.

60. Minor stresses could more readily escalate into financial disruption if investors run into MMMFs perceived as offering safe assets. Such action could result in an abrupt drop in the supply of short-term funding together with a run of non-insured deposits from the banking sector. The Fed has recognized these risks indicating that it will cap access to instruments targeted at the nonbank sector both at the counterparty and aggregate levels. The caps will keep the banking sector more liquid for longer than might otherwise have been the case during the tightening phase. This approach lessens the risk of disruption that could have arisen with a more active reduction in liquidity, but may increase the challenge of controlling short-term money market rates given the uncertainty about the functioning of the fed funds market after the prolonged period of abundant

⁸³ This would inter alia support the monitoring of risk management by some financial intermediaries.

liquidity and in light of the new regulatory environment (i.e., LCR). While the Fed has conducted a considerable amount of testing of its new instruments, there is some uncertainty about the demand for these instruments once interest rates move away from the zero lower bound.

Box 2. Normalizing Monetary Policy, Reverse Repos and Financial Stability^{1/}

The Fed's operating target for monetary policy is the fed funds rate—a market rate of transactions between entities that have accounts at the Fed, not all of which are depository institutions. The Fed remunerates only depository institutions for reserve balances. The rate it pays (interest on excess reserves, or IOER) is one instrument used to align the Fed funds rate with the announced target rate (currently 0–25 basis points). Fed funds trades below the IOER primarily because some entities do not have access to IOER, and banks face an array of balance sheet costs that may be an impediment to arbitrage in the funds market.

QE involved the Fed purchasing assets—U.S. Treasury and agency securities—mainly from non-banks.

The purchase program increased the amount of securities held on the Fed's balance sheet, with the counterpart being an increase in excess reserves; from around \$2 billion pre-crisis to \$2.6 trillion in October 2014 (at the conclusion of the program). An implementation risk during normalization is that an increase in the fed funds target might not translate one-for-one into a tightening in short-term money-market rates more generally—that is, some short rates get left behind, there is poor transmission along the yield curve, and the credibility in the Fed's ability to control monetary conditions is undermined.

Accordingly, the Fed has modified its operating framework by: 1) introducing new instruments to strengthen the interest rate floor and drain reserves—overnight reverse repos (ONRRP), term-reverse repos, and term-deposits (for depository institutions only), and 2) expanding the market operations counterparts that it deals with beyond the pre-crisis primary dealer category (21 dealers) to 164, made up of 106 MMMFs, 22 broker-dealers, 24 depository institutions, and 12 GSEs. With no precedent for tightening commencing from such a large balance sheet, the Fed has conducted tests to better understand the demand for each instrument and the impact on interest rates (Figure 3).

An expanded list of counterparts and new instruments potentially increases financial stability risks, in particular: 1) disruption to short-term funding markets—MMMFs as the main providers of funds through repo markets could abruptly switch to the Fed's facilities causing dislocation in funding and asset markets and 2) disintermediation of the banking system—where uninsured deposits flowed out of banks to MMMFs in a flight to safety event where investors perceived MMMFs as being safer (because of their access to safe assets).

The Fed has signaled that it will manage the financial stability risks through the use of caps on the ONRRP (by counterparty and in aggregate). Limiting non-bank flows to the Fed through quantitative limits on its instruments will mitigate the financial stability risks. The extended period of testing of the new instruments should allow for adequate control over monetary conditions during the normalization period and importantly the Fed has stated that the ONRRP will be phased out when no longer needed to control the fed funds rate.^{2/}

^{1/} See also IMF: USA Selected Issues Paper: The Operational Framework for Monetary Policy: July 2014, and FRB: Overnight RRP Operations as a Monetary Policy Tool: Some Design Considerations 2015-010.

^{2/} Board of Governors of the Federal Reserve System: Press Release September 17, 2014.

Figure 3. ONRRP and Selected Interest Rates

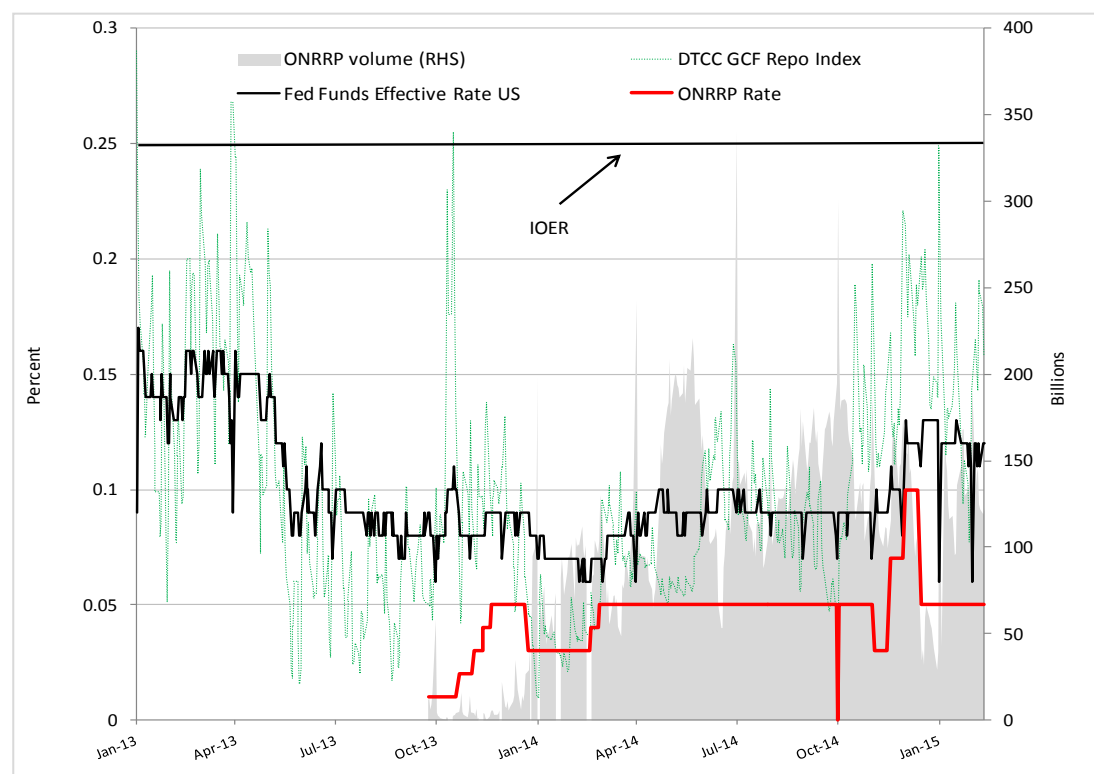

Sources: Bloomberg and IMF estimates.

G. Data Gaps

61. The repo and securities lending markets are large and highly interconnected. In the United States, three segments are relevant: tri-party repo, bi-lateral repo and securities lending. Tri-party repo volumes are known, having fallen from a peak of \$2.8 trillion pre-crisis to \$1.5 trillion. But it is widely expressed that there is considerable uncertainty about the scale and nature of activity in the bi-lateral repo and securities lending markets. The Fed publishes weekly data on dealer activity with volumes outstanding at February 25, 2015 for repos of \$1.7 trillion and for reverse repos \$2.1 trillion but these numbers include both tri-party and bi-lateral activity and need to be adjusted for activity between the dealers to avoid double counting. Further some private firms publish data on securities lending transactions. U.S. Treasuries and government agency securities make up around 80 percent of the collateral provided in tri-party repo transactions (Figure 4) with haircuts generally higher than those recommended by the FSB (Figure 5), particularly with regard to Treasuries given that the FSB recommendations exclude sovereign debt.⁸⁴

⁸⁴ FSB: Regulatory framework for haircuts on centrally cleared securities financing transactions—October 2014.

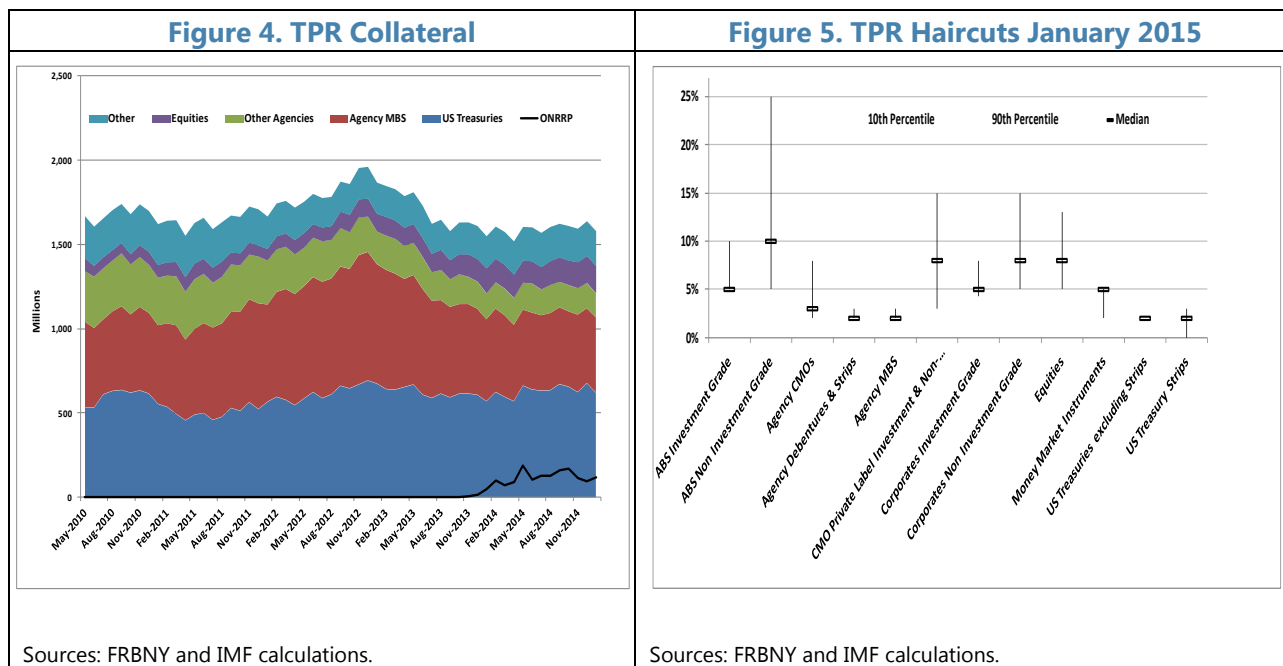

62. The U.S. authorities recognize that data limitations prevent a consolidated assessment of trends and risks across repo and securities lending markets. The OFR together with the Fed and the SEC are working on pilot surveys for bi-lateral and securities lending activity which initially cover a selection of BDs and agent lenders. These initiatives are encouraging, and could be complemented by:

- *Publishing more granular data on tri-party repos—including on cash providers, repo maturities and collateral type and maturity.*

H. Liquidity Backstops

63. Official sector liquidity assistance played a vital role in preserving financial system functioning during the crisis. Financial system safety nets nonetheless may have an impact on risk-taking incentives and so require very careful design. The current U.S. arrangements and the changes introduced since the crisis were reviewed.

64. Post-crisis the discount window, accessible by depository institutions, is unaltered while the Fed’s ability to provide assistance to non-banks has changed. During the crisis the Fed introduced ten programs as well as providing support on a bi-lateral basis to mitigate an array of liquidity-related risks, dealing beyond its usual counterparts of primary dealers and depository institutions. This section assesses the liquidity backstops 1) for banks suggesting a better alignment of policy instruments with objectives; 2) the role of FHLBs; and 3) for nonbanks in the context of the DFA and FSOC designation; and 4) with regard to financial market infrastructures.

Depository Institutions

65. The Fed's discount window was reorganized in 2003 into monetary instrument-type and lender of last resort (LOLR) components.⁸⁵ A wide range of securities and loan collateral is eligible to secure discount window borrowings with haircuts ranging from 1 percent to 72 percent. Discount window operations are conducted by the regional Federal Reserve Banks. The two main components of the discount window currently are:⁸⁶

- **The Primary Credit Program (PCP)**—*The Fed offers overnight funds to adequately-capitalized banks meeting a minimum supervisory rating (Camels ratings 1–3 or equivalent) at 50 basis points above the FOMC's Fed funds target (was 100bps pre-crisis) and with 'generally no restrictions'. The program is intended to be the 'principal safety valve' to ensure adequate liquidity in the banking system, limiting divergence in the fed funds rate from the policy target, and thereby meeting an operational objective with regard to monetary policy. Ordinarily there are no questions asked or restrictions. However lending under this program is ultimately at the discretion of the Fed.*
- **The Secondary Credit Program (SCP)**—*Banks that do not meet the minimum capital and supervisory standards (that is, banks that have Camels ratings 4 and 5) may be able to access funds, overnight or for a longer period to facilitate a return to market funding, through the SCP—priced at 50 basis points above the PCP. Funds obtained under this program may be provided as a short-term bridge to a return to market funding, or to facilitate resolution, and cannot be used for arbitrage or balance sheet expansion.*

66. More clearly defined objectives with better aligned instruments could help overcome stigma, improve operational outcomes and support financial stability. The discount window spans operations with two materially different objectives, while there is a history of reluctance to access the window due to perceived stigma. Though liquidity-providing operations are less in need at the moment, well understood and better targeted instruments will become more important post-exit from QE. Recognizing that a number of components of the monetary operational framework are likely to change post-exit, modifying the discount window operations sooner could be useful. One possible approach would be for the Fed to create a separate facility intended specifically to ensure adequate liquidity, particularly towards the end of the day, in support of smooth functioning of the payment system and the alignment of market rates with the operating target. By changing the financial instrument (e.g., to repo) and using only high quality assets the stigma issue should be reduced: the fact that an entity has high quality assets available for use in short-term operations should convey a sense that it is generally sound.⁸⁷

⁸⁵ The authority for Fed lending to depository institutions is contained in the FRA 10A and 10B.

⁸⁶ In addition, a seasonal credit facility is offered but minimally used.

⁸⁷ Some central banks take the philosophical view that most collateral is potentially acceptable in monetary operations with liquidity and credit risks equalized through the application of margins. Other central banks, however,

(continued)

- *The Fed could create a facility open to well-capitalized depository institutions that are direct members of Fedwire, available from 3pm onwards to address an institution's unexpected shortfall in receipts that may have arisen because of an overall shortage of reserves, with collateral limited to Treasury and agency securities.*

The Federal Home Loan Banks: Liquidity Recyclers in Times of Stress

67. The Federal Home Loan Banks (FHLBs) provide approximately 8,000 members with short and long-term funding through secured lending programs.⁸⁸ Each of the 12 privately owned co-operative FHLBs is jointly and severally liable for the Consolidated Obligations issued on behalf of any of the FHLBs. This co-operative arrangement together with an implicit Government guarantee enables the FHLBs to access markets on terms that members' individually cannot. Further, the collateral requirements are stringent and the FHLBs have a super lien over the assets of borrowers in the event of resolution under federal receivership—another factor contributing to their ability to access market funding on good terms. No FHLB has suffered a credit loss on its secured loans ("advances") to members. By virtue of this ability to raise funds during times of stress, the FHLBs are able to recycle liquidity to their members that may otherwise have been frozen out of interbank and other short-term funding markets. Lending to members must be secured against performing loans and high-quality collateral at a rate which is a function of a number of factors including the size of the haircut, a requirement to purchase stock (and the right to receive dividends), and a term premium—each regional bank can set its own rate.

68. The FHLBs were an important source of funding during the crisis, complementing the Fed's programs. When funding markets tighten, members can turn to the FHLBs or to the Fed. In the initial period of the last crisis, members first used the FHLBs rather than the Fed's Discount Window because it was cheaper and without the stigma associated with the latter. FHLB advances peaked at over \$1 trillion in September 2008 (c.f. \$536 billion at June 2014), but as the Fed quickly reduced its policy rates and introduced a range of facilities, borrowing from FHLBs diminished.

69. Official sector incentives are increasingly shaping banks' interactions with the FHLBs, with heightened systemic liquidity risks should the FHLBs lose preferential access to bond markets. FHLB loans of less than 30-days are treated more favorably in the LCR than other wholesale funding, allowing an assumption of 75 percent rollover, rather than as a full outflow. Therefore 30-day funding drawn from the FHLBs and fully reinvested in level one high quality liquid assets provides a substantial boost to a bank's LCR. And banks appear to be responding to these incentives with four of the largest banks increasing their funding by 150 percent between March 2012 and December 2013.⁸⁹ This activity increases the interconnectedness of the banks and the

take the view that different collateral pools should be used for different operations, with more liquid assets being used for regular operations. Policy choices here should not unduly impact financial asset pricing.

⁸⁸ The FHLB membership comprises banks, thrifts, credit unions and insurance companies.

⁸⁹ OFR Annual Report 2014 noted that much of this funding was used to acquire high quality liquid assets that can include GSE (including FHLBs) debt.

FHLBs and it is not clear whether FHFA prudential standards for FHLBs are calibrated appropriately to meet the increased liquidity risks of such interconnectedness. The U.S. authorities should consider the systemic implications of the FHLB funding arrangements:

- *The calibration of the LCR which allows for preferential treatment of FHLB funding; and*
- *The adequacy of FHFA liquidity and capital requirements imposed on the individual FHLBs, in light of the apparent increase in interconnectedness with banks.*

Liquidity Backstops: the DFA and FSOC Designation

70. The adoption of the DFA introduced new constraints for the Fed to provide liquidity backstops to non-bank firms.⁹⁰ In addition to the ‘unusual and exigent circumstances’ requirement, programs must involve broad-based eligibility, be pre-approved by the Treasury and with ex-post reporting to Congress.⁹¹ While the DFA now limits the Fed’s response in a crisis, it is likely that most of the programs offered during the crisis would meet the broad-based eligibility criteria.⁹² Still, the question is whether the DFA undermines the Fed’s ability to respond to developments in the non-bank financial sector which if left unaddressed, could spillover into a systemic event.

71. Designation of NBFIs is not linked to potential Fed liquidity support in unusual and exigent circumstances. FSOC designation of a NBFi means that the FSOC has determined that the company’s material financial distress, or activities, could pose a threat to U.S. financial stability—and as result it may be required to have increased buffers against certain risks. But the Fed cannot provide liquidity support to a troubled systemically important NBFi. The following recommendation is guided by the principle that any such backstop should be designed to minimize moral hazard risks to taxpayer resources.

- *The broad-based eligibility criteria should be reviewed, with consideration given to allowing the Fed, at its discretion, to extend liquidity support to any solvent individual institution that is designated by the FSOC (DFA Title I) as being systematically important. The Fed would need to ascertain solvency before extending any such lending, and is encouraged to complete the proposals and subsequently establish heightened prudential standards for designated non-banks as required by DFA.*

⁹⁰ Federal Reserve Act s13.3.

⁹¹ Within seven days of assistance being granted the Fed must report to the Committee on Banking, Housing, and Urban Affairs of the Senate and the Committee on Financial Services of the House of Representatives.

⁹² Exceptions here are the Transitional Credit Extension which was targeted at U.S. and London broker-dealer subsidiaries of Goldman Sachs, Morgan Stanley and Merrill Lynch, and liquidity facilities offered to AIG and Bear Stearns.

Liquidity Backstops: Financial Market Infrastructures

72. In extreme circumstances, if no other funding is available, central banks should stand ready to provide liquidity backstops to solvent, systemically important FMIs.⁹³ Private sector liquidity must constitute the first line of defense for CCPs against liquidity shortfalls, in a way that ensures that a CCP has adequate liquidity self-insurance. There could, nevertheless, be extreme circumstances in which a CCP's liquid resources turn out to be insufficient or unavailable, and yet its continued operation might be vital to sustaining financial stability. Providing solvent CCPs with access to emergency central bank liquidity, against collateral, ensures that the CCP can continue to make payments to counterparties and would thereby maintain the stability of the market. A CCP should not assume the availability of emergency central bank credit as part of its liquidity plan.

73. Under the DFA the Fed may now provide liquidity backstopping to all designated FMUs under certain conditions. The FRB may authorize a Federal Reserve Bank to provide emergency credit to designated FMUs in unusual or exigent circumstances and subject to certain statutory conditions and any additional conditions set by the FRB. The DFA does not require a designated FMU to be a bank or bank holding company. However, emergency credit can only be provided upon majority vote of the FRB after consultation with the Treasury (section 806b). The designated FMU would have to show that it is unable to secure adequate credit accommodations from other banking institutions. Preparing contingency plans for the provision of emergency liquidity to designated FMUs, without pre-committing to such support, should be considered.

INVESTMENT FUNDS AND SYSTEMIC RISK

A. Asset Managers and Market Liquidity Risks

74. Liquidity management tools available to U.S. open-ended mutual funds (MFs) equip them well to handle normal cyclical volatility. A combination of factors allows MFs to maintain thin liquidity (cash) buffers during their normal course of business, relying instead on market liquidity in the assets they hold. Indeed, passive (index) funds may not be able to hold significant cash buffers as they would then deviate from their benchmark portfolio and violate constraints on tracking error deriving from their investment mandates.⁹⁴

- First, large investors in particular need to take account of the price impact of their sales, especially in stressed market conditions, which could act as a disincentive against runs.

⁹³ See April 2010 International Monetary Fund Global Financial Stability Report.

⁹⁴ Market liquidity of assets into which MF investors' holdings are invested can be significantly eroded when these markets are under stress ("bad weather liquidity") relative to normal times ("fair weather liquidity"). Such funds can potentially raise cash buffers without increasing tracking error by using derivatives markets (e.g., total return swaps) but this strategy would raise counterparty credit and market risks which is unlikely to be consistent with such funds' investment mandates.

- Second, individuals' and households' defined contribution retirement plans and individual retirement accounts represent a major investor class which, as of December 2013, constituted close to 50 percent of assets of equity, bond and hybrid MFs. These investors are a source of stability for asset markets since a review of their strategic asset allocation is undertaken at a lower frequency: a fall in relative prices of specific assets would normally induce purchases of these securities by these investors through their mutual funds. Target date MFs, offering a long-term investment strategy to households and retirement plans, are a good example and have been cited as an important factor in tempering outflows from bond funds in 2013.
- Third, MFs are allowed by regulation to borrow up to 33 percent of the market value of their (net) assets under management and can do so to meet unanticipated increases in redemption demand.

75. MFs could be susceptible to runs during severe market stress that could exert adverse knock-on impact on the asset markets in which they operate. MFs have a regulatory obligation to meet redemption demand in cash within 7 days which, at times of stress, they may be unable to meet.⁹⁵ As noted above, cash and other liquidity buffers are limited, at least for passive MFs by their need to minimize tracking error, and alternate means of expanding liquidity buffers such as repos and bank credit lines may be subject to wrong-way risk, or become unavailable during times of severe market stress when they are most needed.⁹⁶ Moreover, during such episodes, the equilibrating effect of retirement plans may be insufficient or absent, leaving MFs with no recourse but to sell assets in the open market at a steep discount.

76. The rapid expansion of MFs into certain markets has brought these concerns into sharper relief.⁹⁷ The significant recent rise in MFs' investments into (high yield) corporate bonds, emerging market (EM) debt, bank loans, and municipal bonds has coincided with a notable decrease in liquidity in some of these markets, particularly for corporate bonds.⁹⁸ Stress tests undertaken by the mission illustrate that for corporate and municipal bonds, a spike in redemptions by MF

⁹⁵ The obligation to settle claims of exiting investors in 7 days is required under Section 22(e) of the Investment Company Act of 1940 except under exceptional circumstances as determined by the SEC. It is supported by the requirement that such funds hold at least 85 percent of their assets in instruments that the asset manager determines can be liquidated within a week.

⁹⁶ Use of bank credit lines is also limited by desire to avoid portfolio composition changes that may interfere with the funds' ability to track its investment mandate and also, during market stress events, by reputation concerns.

⁹⁷ The quantitative information cited in this paragraph is sourced from BlackRock's "Who Owns the Assets? A Closer Look at Bank Loans, High Yield Bonds, and Emerging Markets Debt" (September 23, 2014). An increase in open-end MFs' total (net) assets (TNA) held can arise due to two factors, net inflows into the funds or an increase in the market value of the funds' assets. For the markets discussed in this paragraph, detailed examination of data suggests that net inflows represent the primary factor driving the increase in TNA for bond funds since the start of the global financial crisis.

⁹⁸ The inventory held by dealers represents one commonly-used metric of market (trading) liquidity as it provides an indicator of the volume of assets that these key market makers are willing to hold and the volume of sales orders that may be smoothly absorbed by the market (see figures 6 and 7— for further details see the accompanying Technical Note on Stress Testing).

investors corresponding to a tail event could be problematic for the market to absorb given reduced dealer capacity and willingness to act as market makers in all conditions.

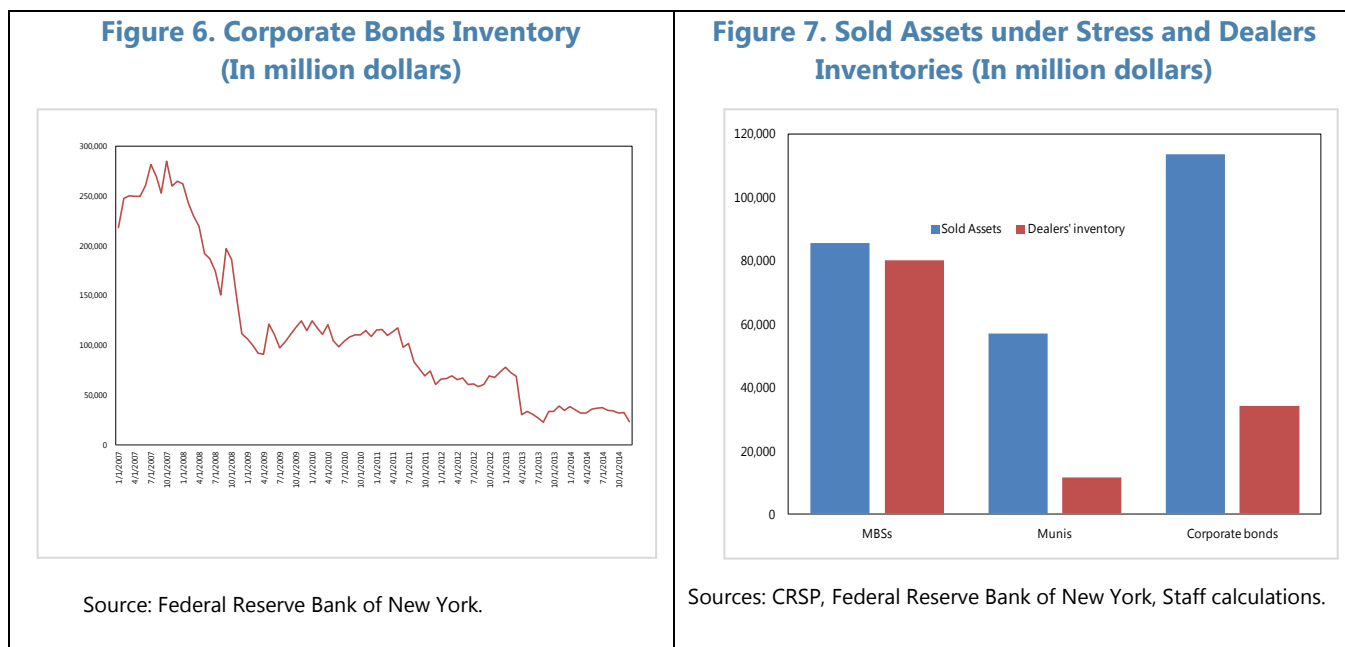

- Bank loans: U.S. MFs held over \$150 billion (25 percent of total held by non-banks) as of December 2013. Bank loans have longer settlement periods than for securities, potentially causing liquidity mismatches for funds when they offer daily liquidity.
- HY corporate bonds: MFs and ETFs held \$555 billion (over a third of the \$1.5 trillion outstanding as of December 2013) of which the bulk (\$477 billion) was held by dedicated HY bond funds. The average cash ratio of dedicated HY funds, at around 3 percent, was close to a four year low as of June 2014. HY funds' AuM has grown by over 14 percent on an annual basis since 2008 as large institutional investors have increased their asset allocation to the underlying assets under pecuniary incentives generated by the low-for-long rates environment.
- EM debt: MF holdings total \$380 billion.⁹⁹ Holdings are concentrated in internationally-issued EM debt rather than the more liquid local-currency denominated debt. Besides the lower secondary market liquidity, repo agreements are typically not available in these markets. Funds usually manage liquidity risk through a combination of asset diversification within their benchmark, holding cash—albeit cash ratios were at historic lows prior to the taper tantrum—and allocating a small share to developed market debt.

⁹⁹ Besides US mutual funds and ETFs, this figure also includes investments made by EU and retail mutual funds.

77. Liquidity risks have also increased in the ETF space since the global financial crisis.

- **The traditional U.S. ETFs, offering passive equity indexation with physical replication, are liquidity-enhancing investment vehicles.** The tiering of the market provides a two-fold cushion against redemption spikes feeding into negative asset price spirals. First, when a redemption spike causes the ETF shares to trade at a discount to NAV in the secondary market, it provides an incentive to market makers and authorized participants to arbitrage the difference by offering exiting investors the desired liquidity. Second, redemption-in-kind stops the automatic translation of redemptions to asset sales.
- **Asset managers have taken advantage of the search-for-yield triggered by the low interest rate environment by offering ETFs tracking HY bonds, EM assets, municipal bonds, and bank loans, where the perception of enhanced liquidity could be seriously misplaced.** This concern was crystallized during the taper tantrum by the widening discount of municipal bonds' ETF share prices to ETF NAV and the inability of a prominent market maker to continue providing liquidity to investors in the secondary market for EM ETF shares. Redemption-in-kind is the structural feature of ETFs that normally prevents redemption spikes from directly hitting the underlying asset markets. But it can be expensive for ETF market makers and/or authorized participants to exploit arbitrage opportunities by providing liquidity in the secondary market (due to higher prudential capital and liquidity charges of warehousing these assets on their balance sheets) if the underlying assets are difficult to liquidate in a short period of time. This means that, under stressed market conditions, ETF investors may only be able to liquidate shares at a very steep discount to the NAV or not at all, belying the liquidity assumptions investors may have made while entering this market.

78. Market liquidity risks are also increased by a combination of factors that raises U.S. MF investors' incentives to run with the herd.

- First, regulation compels MFs to pay exiting investors the NAV prevailing on the day they demand redemption, rather than the NAV on the day when the corresponding sale of assets takes place.¹⁰⁰ Any difference between these NAVs is absorbed by the MF and thus its remaining investors. This likely makes no difference in normal times when trades are almost always settled within a short period of time without a material movement in NAV. But it could be very costly to the remaining MF investors during periods of stress when sales are delayed and prices are falling fast.
- Second, while MFs' ability to borrow to meet redemption demand provides a liquidity management tool, the leverage assumed becomes an obligation of investors remaining

¹⁰⁰ Regulation 2a-4 allows up to next day redemption, but it can be and often is same day.

invested in the MF. During periods of sustained outflows, extensive use of this strategy could result in an acceleration of NAV erosion, and hence, exacerbate the incentive to run.¹⁰¹

- Third, MFs often apply single pricing to inflows and outflows instead of the prevailing bid and offer prices. Hence, they transfer value from the MF to exiting investors, also exacerbating the incentive to exit when the NAV is falling rapidly.

79. Options to reduce the incentive to run should be explored. The following proposals are suggested:

- *Settlement to exiting investors should accurately reflect sales prices of assets liquidated where asset sales are made to redeem the claims. This could include a change in settlement to sales-date NAV instead of redemption-date NAV, and to actual sales price (the bid price) from mid-price. Where leverage is used to settle redemption claims, redemption fees could be increased to reflect the expected cost to the MF.*

B. Securities Lending by Mutual Funds

80. Many MFs are actively engaged in securities lending and corresponding (cash) collateral reinvestment. In the event of a redemption run, especially if in the context of a risk-off event or general funding shock, recall of cash and securities lent out to meet investor demand could exacerbate existing pressures and shortfalls in these critical capital markets. Strong risk management practices are paramount to avoiding securities lending businesses becoming an excessive source of risk to the fund and its investors, and hence, to avoid panics and runs should securities borrowers seek to exit transactions in large volumes.

Why lend securities?

81. Subject to the oversight of a funds' board of directors, a MF may lend securities.

- **For index MFs** that use physical replication, income from securities lending and (cash) collateral reinvestment covers shortfalls between fund returns and benchmark returns that arise from tracking error.
- **For asset managers whose revenues rely exclusively or principally on AuM volume,** securities lending income allocated to investors could, when in excess of tracking error shortfall, provide incentives to attract more AuM and, hence, more income going forward.
- **For asset managers whose MFs contract with affiliates for managing their securities lending and collateral reinvestments,** this business may be an important source of income.

¹⁰¹ It is doubtful that funds could meet redemptions over a longer period of time with credit lines.

Regulatory treatment

82. Securities lending. MFs and ETFs that lend securities are subject to various regulatory constraints. These include lending limits of no more than 33 percent of total assets. The loans must be collateralized at least 100 percent and marked-to-market daily.

83. Cash collateral reinvestment. Cash collateral reinvestment generally is limited to “short-term highly-liquid instruments as determined by the fund’s adviser subject to the oversight of the funds’ board of directors.” Certain fund cash collateral investments in joint accounts with affiliated entities or in affiliated pooled investment vehicles are subject to specific regulatory constraints on eligible classes of instruments and on the liquidity and maturity of instruments.

Risk management

84. Securities lending and the reinvestment of collateral can, in principle, add to the portfolio management and operational risks for funds and their investors. Since the two legs of this business involve the transformation of one portfolio of assets into another and contracting with potentially risky counterparties, it can entail increases in credit, liquidity, and maturity risks which need to be contained and managed. The experience of AIG’s securities lending and reinvestment activities during the financial crisis suggests that, absent adequate risk controls and supervision, considerable liquidity and credit risks could be accumulated by investing in assets that can become illiquid and difficult to price during times of stress but which had passed the prudential criteria for collateral reinvestment in normal times. A more typical example in the present day could be a MF lending on-the-run 10 year U.S. treasury bonds, renegotiated on a daily basis, and using the cash raised to reverse-in off-the-run 10 year U.S. treasury notes (liquidity transformation) with a term of 31 days (maturity transformation).

85. Where agents’ services are required to conduct securities lending, it is important for funds and their boards to manage agency incentives to limit moral hazard risks. Agent lenders, who may be custodians or, in some cases, affiliated with the funds’ asset manager typically manage the securities lending and sometimes the collateral reinvestment legs of the business and indemnify the fund against losses on the first leg (but normally not for the second). Agent lenders are compensated by a fee and share in the income from the securities lending program including income from reinvestment of cash collateral. Agent lenders’ contracts need to be structured in a manner that aligns the agent lenders’ interests with those of the lender.

86. Data gaps are substantial, making comprehensive assessment of financial stability risks arising from funds’ securities lending activities difficult, albeit available information does not suggest cause for alarm. Agent lenders’ pay contracts are structured as two-part tariffs and their share in funds’ income from securities lending can be substantial, at 25 percent or higher. While in principle this can increase their risk taking incentives, in practice, investors have reportedly been proactive in securing safer mandates from asset managers after the crisis. This combined with BDs’ desire to term out repos has reportedly redirected funds’ cash collateral towards investments in

MMMFs. While this contains credit and maturity risks, MMMFs' ability to impose redemption gates may create liquidity risks to mutual funds during times of stress.¹⁰²

87. There is considerable merit in imposing more comprehensive disclosure requirements on funds with respect to their securities lending activities. Information on the amount of securities lent, investment portfolio of cash collateral received, maturity mismatches across these two transactions legs, counterparties, and income sharing between the funds and their agent lenders, is not disclosed.¹⁰³ This makes it difficult to understand the nature of financial risks to funds and markets of their activities. The experience of AIG and the NAIC's subsequent enhanced disclosure rules on insurers' securities lending activities strongly suggests that imposition of similar disclosure requirements on players active in this market more broadly would bring considerable benefits for the oversight of financial stability.

- *The pilot survey of the OFR, FRB, and SEC to collect and examine data on securities lending activities and the FSOC Request for Comments on Asset Management Products and Activities are very welcome. It is recommended to use insights from this exercise to extend data disclosure requirements on securities lending activities across the industry.*

SYSTEMIC RISK OVERSIGHT OF FINANCIAL MARKET INFRASTRUCTURES

A. Overview of FMIs in the United States

88. U.S. FMIs are amongst the largest in the world. Clearing and settlement volumes position U.S. FMIs at the top of international rankings as illustrated by the tables in Appendix 5. The value of transactions for designated FMUs, Fedwire Funds and Fedwire Securities was in the trillions of U.S. dollars during 2013. The Fixed Income Clearing Corporation (FICC) topped the list with a value of transactions of \$1,155 trillion, followed by the Fedwire Funds system with \$713 trillion. The United States also provides a home to two of the largest OTC derivatives CCPs in the world, i.e. the Chicago Mercantile Exchange (CME), with an outstanding amount of \$27 trillion in interest rate swaps (IRS), and ICE Clear Credit (ICC), with an outstanding amount of \$928 billion in credit default swaps (CDS). Daily exposures of CCPs are in billions of dollars.

89. Some U.S. FMIs are systemically important at a global level, and the importance of the CCPs amongst them is expected to grow.¹⁰⁴ FMIs provide the central infrastructure to clear and settle payments, as well as securities and derivatives transactions and therefore lie at the core of the

¹⁰² Of course, to the extent that MFs reinvest cash collateral in MMMFs that are not subject to gates e.g., government MMMFs, they would avoid risk of their holdings being gated.

¹⁰³ MFs disclose some of this information in their periodic reports. The reporting forms and technology do not, however, allow for systematic industry-wide analysis by regulators.

¹⁰⁴ See the FSOC Annual Report 2012, Appendix A.

functioning of interbank, money, and capital markets. Most G-SIFIs participate in U.S. FMIs. These participants represent thousands of customers, including correspondent banks, investment companies, and nonfinancial corporations, both domestic and foreign. Multiple memberships of U.S. banks in CCPs around the world further interlink the U.S. and global financial system. U.S. FMIs are crucial to U.S. dollar clearing, for example the Fedwire Funds and CHIPS. CCPs that clear OTC derivatives are of key importance to the safe and efficient functioning of global OTC derivatives markets. Their importance is growing due to the G-20 mandate to clear standardized OTC derivatives through CCPs. Disruption of critical operations at one of the U.S. FMIs may spread to their participants, other FMIs, markets, and throughout the U.S. and global financial systems.

90. The U.S. FMI landscape is highly interconnected and interdependent. All FMIs directly or indirectly depend on the Fedwire Funds system to settle large value interbank payments as illustrated in Appendix 6. The FICC and NSCC are dependent on DTC to facilitate settlement of securities transactions in government and corporate securities transactions, respectively. Almost all systemically important CCPs are linked to other CCPs through cross-margining arrangements.¹⁰⁵ Appendix 7 illustrates and describes the different cross-margining arrangements. Although ICE is not linked to another CCP, ICE Clear U.S., which is also a subsidiary of International Exchange Inc., has a cross-margining arrangement with the Options Clearing Corporation.

B. Regulation and Supervision of FMIs

91. In July 2012, FSOC designated eight FMIs as systemically important FMUs, based on the criteria provided by DFA Title VIII. Designation, among other things, allows the appropriate supervisory agency to impose enhanced risk management standards and supervision on the designated FMU. The designated FMUs comprise The Clearing House (as operator of CHIPS), CLS, the central securities depository (CSD) and securities settlement system (SSS) DTC, and five CCPs, which are the CME, FICC, ICE, the National Securities Clearing Corporation (NSCC) and the Options Clearing Corporation. The outcome of the designation was made public through the 2012 FSOC report, including a description of each designated FMU and a detailed rationale of its systemic importance.¹⁰⁶

92. Designated FMUs are primarily regulated, supervised and overseen by the FRB, SEC, or CFTC, depending on their activities. DFA Title VIII generally defines a supervisory agency as the federal agency that has primary jurisdiction over a designated FMU under federal banking, securities, or commodity futures laws. In the case of a CCP that is subject to the jurisdictional supervision of more than one agency (for example, the SEC and the CFTC), the agencies agree which is the supervisory agency authorized to prescribe and implement the enhanced risk management

¹⁰⁵ A cross-margining arrangement is an agreement among CCPs to consider positions and supporting collateral at their respective organizations as a common portfolio for participants that are members of two or more of the CCPs. This reduces collateral requirements for clearing participants and helps to improve their liquidity and capital efficiencies.

¹⁰⁶ See Appendix A of the 2012 FSOC report.

standards under Title VIII, or if the agencies cannot agree, the FSOC will decide. Title VIII of the DFA provides the FRB with enhanced authority over all designated FMUs in several areas, for example, the FRB may determine that the existing prudential requirements of the CFTC and SEC with respect to their designated FMUs are insufficient to prevent or mitigate significant liquidity, credit, operational, or other risks to the financial markets or to the financial stability of the United States and report its concerns to FSOC. Also, the FRB has the right to participate on Title VIII examinations led by other supervisory agencies and has certain back-up supervisory authorities in emergency circumstances (it may take enforcement actions directly when necessary and with the Council's approval). Table 2 outlines the primary responsibilities of the different authorities for designated FMUs as well as for other U.S. FMIs.

93. There is room to increase transparency on the applicable regulatory regimes for U.S. FMIs, including on the designation of systemically important FMUs. For certain FMIs, including but not limited to those which have been designated as systemically important by the FSOC, the applicable risk management standards are intended to be consistent with the PFMI. Other FMIs that have not been designated as systemically important have nevertheless opted to comply with the PFMI to be classified as qualifying CCPs.¹⁰⁷ There are also CCPs that have not been designated as systemically important and that are not subject to the enhanced risk management standards derived from the PFMI. In addition, no FMI organized outside of the United States has been designated by FSOC.¹⁰⁸ Increased clarity on the applicable regulatory and supervisory regimes for the different FMIs, for example through an explanation on the website of the appropriate authority, may contribute to sound decision making of the FMI's participants, authorities and the public. Explanations on the identification process for designation of FMUs could allow, for example, for external replication of the decisions, improving the transparency of the designation process of systemically important FMUs.¹⁰⁹ Careful drafting of these explanations would be necessary to limit legal and political risks.

- *Given the complex framework of FMIs in the United States more robust disclosure of the applicable regulatory and supervisory framework for different FMIs, including an explanation for the different determinations, would bring additional transparency.*

94. The regulatory and supervisory framework for systemically important FMUs prescribed by the DFA entails major improvements that should help reduce systemic risks. Prior to the DFA the supervision and oversight of FMIs was spread across several regulators depending on the system's charter or the markets it cleared for. The DFA in Title VIII expands the FRB's role, in coordination with the CFTC and the SEC, in the supervisory examination planning, participation in

¹⁰⁷ Clearing members may apply reduced capital requirements for their exposures to qualifying CCPs; see *BCBS Capital requirements for bank exposures to central counterparties, April 2014*.

¹⁰⁸ Such as ICE Clear Europe LLC (ICEEU), LCH Clearnet Limited, LCH Clearnet SA, and Singapore Exchange Derivatives Clearing.

¹⁰⁹ This might be as simple as noting that the DFA only envisages designating U.S. incorporated private-sector FMIs, and that designation of the systems operated by the Fed would make no practical difference.

examinations and consideration of material rule changes helping to establish a consistent framework across supervisory authorities for systemically important FMIs. In cooperation with other agencies and complementary to existing supervisory and regulatory provisions, this should assist the FRB in addressing systemic risk consistently, and strengthen its ability to induce change where necessary. The DFA also allows the FRB to authorize a Federal Reserve Bank to offer accounts and services for designated FMUs.

Table 2. Primary Supervisory Agency and Application of Enhanced Risk Management Standards for U.S. FMIs

		Federal Reserve	CFTC	SEC
Application of enhanced risk management standards	By FSO designation	<ul style="list-style-type: none"> The Clearing House Payments Company, L.L.C., on the basis of its role as operator of the Clearing House Interbank Payments System (CHIPS) CLS Bank International (CLS) 	<ul style="list-style-type: none"> Chicago Mercantile Exchange (CME) ICE Clear Credit L.L.C. (ICE) 	<ul style="list-style-type: none"> Depository Trust Company (DTC) Fixed Income Clearing Corporation (FICC) National Securities Clearing Corporation (NSCC) Options Clearing Corporation
	By policy	<ul style="list-style-type: none"> Fedwire Funds Service Fedwire Securities Service 		
	By FMI opt-in		<ul style="list-style-type: none"> ICE Clear U.S. LCH.Clearnet L.L.C. Minneapolis grain exchange 	<ul style="list-style-type: none"> Depends on final SEC rules
Other FMIs not subject to enhanced risk management standards		<ul style="list-style-type: none"> FedACH¹ 	<ul style="list-style-type: none"> The Clearing Corporation Cantor Clearinghouse North American Derivatives Exchange 	<ul style="list-style-type: none"> Omgeo Depends on final SEC rules
Sources: Federal Reserve, CFTC, SEC.				
^{1/} Other retail payment systems, such as EPN, SVPCo, Viewpointe and several card networks are examined as a bank service company by Federal Financial Institutions Examination Council (FFIEC) agencies.				

95. The DFA also provides the agencies with additional tools to supervise designated FMUs, which contributes further to consistent and strengthened supervision and oversight.

The two major tools are annual examinations and prior review of material changes to a designated FMU's rules, procedures or operations. Designated FMUs must submit for enhanced prior review to their supervisory agencies proposed changes that could materially affect the nature or level of risks presented by the utility. And the relevant supervisory agency is required to examine each designated FMU at least annually to determine: (1) the nature of its operations and risks it bears; (2) the financial and operational risks it presents to financial institutions, critical markets, or the broader financial system; (3) its resources and capabilities to monitor and control such risks; (4) its safety and

soundness; and (5) its compliance with DFA Title VIII (the risk-management standards prescribed by its supervisory agency under Title VIII). Such examinations are conducted in consultation with the FRB as to the scope and methodology of the examination. The FRB also may participate, at its discretion, in such examinations.

96. The U.S. authorities have officially considered the PFMI in the development of their rulemaking under the DFA and are making progress towards completely and consistently implementing them, which is expected to further decrease systemic risk. Under the DFA, designated FMUs have to comply with enhanced risk management standards prescribed by their supervisory agencies, taking into consideration relevant international standards. The CFTC and FRB issued final rules, implementing the enhanced risk management standards for designated FMUs, in 2013 and 2014 respectively. The SEC final enhanced standards are yet to be promulgated, with no publicly defined deadline. The February 2015 CPMI/IOSCO Level 2 assessment concluded that the U.S. jurisdiction had made good progress towards completely and consistently implementing the majority of the Principles applicable to systemically important CCPs and identified a few areas in which the relevant authorities could improve the completeness of the existing and proposed regimes and their consistency with the Principles.¹¹⁰

97. It is important that SEC rules for covered clearing agencies are finalized soon. The FMIs subject to the CFTC's supervision, i.e., CME and ICC, had to apply the CFTC enhanced regulatory regime as from December 2013. FMIs subject to oversight by the FRB, i.e., CLS and CHIPS, are currently implementing the new requirements and need to comply by the end of 2014, with a one-year transition period for a subset of requirements. SEC rules on enhanced standards for covered clearing agencies are not yet final. Those are expected to cover the following areas, which are highly relevant in terms of risk management: (1) general organization (including requirements for legal basis, governance, and a comprehensive risk management framework); (2) financial risk management (including requirements for credit risk, collateral, margin, and liquidity risk); (3) settlement (including requirements for settlement finality, money settlements, and physical deliveries); (4) default management (including requirements for default rules and procedures and segregation and portability); (5) business and operational risk management (including requirements for general business risk, custody and investment risks, and operational risk management); (6) access (including requirements for access and participation, tiered participation arrangements, and links); and (7) transparency.

- *It is recommended to promptly finalize implementing the PFMI standards, through completion of rules by the SEC and implementation of these rules by the relevant FMIs.*

¹¹⁰ Title VIII provides that the CFTC and the SEC "may each prescribe regulations, in consultation with the Council and the Board of Governors, containing risk management standards, taking into consideration relevant international standards and existing prudential requirements, for those designated clearing entities and financial institutions engaged in designated activities for which each is the Supervisory Agency or the appropriate financial regulator..." Relevant international national standards include the PFMI. See CPMI/IOSCO Implementation monitoring of PFMIs: Level 2 assessment report for central counterparties and trade repositories—United States, February 2015.

98. The three agencies have been increasing the level of their human resources in light of their expanded mandates and should ensure that they get the appropriate levels, both in quantity and quality.

As a result of the DFA, the work load of the agencies has substantially increased in rule making, supervision, data gathering and cooperation activities. Consequently, the internal teams are being reinforced by additional staff, either through external hiring or internal reallocation, budget permitting. In addition, training efforts are under way to align staff competencies to their new responsibilities. Supervisory efforts have developed substantially and should continue to evolve as supervisors gain experience assessing firms against new regulations.

- *Ensuring sufficient number of qualified staff will allow adequate enforcement of the enhanced rules.*

99. Given the distribution of FMI supervision among several agencies, domestic cooperation is key to achieve consistency and avoid loopholes.

Post DFA, supervisory arrangements remain quite complex, involving three agencies. In some cases, a particular FMI is supervised by more than one agency. In particular, the CFTC, the SEC, and the FRB, have responsibilities regarding CCPs depending in part on the activities of the CCP (i.e., products cleared), and in part on whether the CCP has been designated as systemically important. The DFA has substantially improved cooperation between and among domestic supervisory agencies, providing a new cooperative supervisory framework for designated FMUs. Coordination and cooperation is furthered by the fact that the agency heads are voting members of the FSOC, which meets monthly, and staff of the three agencies routinely interact through participation in various FSOC committees, in particular the FMU and the Systemic Risk Committees.

100. The U.S. agencies are among the frontrunners in shaping international reforms. Public reporting by the FSB and standard setting bodies indicates that the United States is among the frontrunners in shaping international reforms. Enhanced consultation, cooperation, and data sharing at the international level would further promote the safety and efficiency of cross-border or multicurrency FMIs, while sharing macroprudential information from FMIs can be useful for detecting emerging risks to financial stability. This is particularly relevant given the global importance of U.S.-based FMIs and the increasing reliance of some U.S.-based market participants on FMIs in other jurisdictions and vice versa. International cooperation is also key to minimize extra territoriality issues. The global regulatory reforms for OTC derivatives clearing potentially expose the CCPs and some of their participants to legal risk due to conflicting requirements.

- *U.S. authorities should continue their discussions with relevant foreign authorities to address conflicts of law and help level playing-field concerns.*

C. System-Wide Risks Identification and Management

101. Identification of system wide risks is important to address potential threats to the financial stability. Risks are identified and managed by FMIs and their primary supervisory agencies. Given that the U.S. financial landscape is a tight, interdependent, interconnected network of FMIs, banks, financial institutions and service providers, and that regulatory, supervisory and oversight responsibilities for FMIs are divided among several agencies, it is important, given the size and scope of U.S. FMIs, to take an additional system-wide perspective in identifying risks that have an overarching nature, and that may not be necessarily identified within the scope of the risk management activities of the individual FMIs and their primary authorities.

102. Cybercrime is one of the system-wide risks identified by the FSOC that is relevant for FMIs. Under the umbrella of the FSOC, the Treasury, regulators, other government agencies, and private sector financial entities work together to improve insights on cyber security. This is expected to contribute to the awareness and assessments of cyber risks and the quality of oversight of the financial sector, including FMIs.¹¹¹ In its 2014 Annual Report, the FSOC recommends further actions to improve crisis coordination mechanisms and testing of crisis communication protocols, including with international regulators. In addition, the FSOC recognizes the importance of removing legal barriers to information sharing between public and private sector entities.

103. While identification of system-wide risks in relation to FMIs is currently underway, it would benefit from a more systematic approach. Identification of these risks, within authorities as well as within the FSOC structure, could further contribute to the effectiveness of the systemic risk oversight within the United States. Among the issues meriting further analysis are:

- *FMIs' dependency on banking services of only a few G-SIBs: U.S. FMIs are highly dependent on services of a few commercial banks and the failure of such a service provider would pose severe distress on all or a large majority of the FMIs in the United States (see also next paragraph).*
- *Membership of banks in multiple FMIs: Various financial entities participate in several or all FMIs. The default of such a participant may cause severe distress at one or more FMIs and exacerbate stressed market conditions.*¹¹²
- *Pro-cyclicality of margin calls: Collateral requirements imposed on clearing members can increase abruptly in times of sudden market volatility and exacerbate market pressures.*
- *Cross-margining arrangements: U.S. CCPs manage the risks related to their cross-margining arrangements as part of their regular credit and liquidity risk management framework. Although*

¹¹¹ In February 2014, the U.S. National Institute of Standards and Technology (NIST) released the Framework for Improving critical Infrastructure Cybersecurity, with the objective to enhance the security and resilience of the U.S. critical infrastructure, and referencing global standards for cyber security.

¹¹² In case of a participant's default CCPs may try to dispose of collateral to cover their losses. If several CCPs try to sell the same type of assets, collateral markets might in extreme circumstances exhibit high volatility and price peaks.

exposures of cross-margining arrangements are currently modest, risks may build up and be a channel through which credit and liquidity shocks can be distributed.

104. Findings can feed into macroprudential tools as well as support the development of recovery and resolution plans. The OFR has started analyzing the use of network analysis to further improve the understanding of the FSOC in relation to exposures among financial firms and potential channels of contagion.¹¹³ Inclusion of FMIs in the network analysis efforts could be useful.

- *It is recommended to develop a systematic approach for identifying and responding to system-wide risks related to interdependencies and interconnections among FMIs, within individual supervisory authorities and the FSOC structure.*

105. Concentration of service provision by G-SIBs to FMIs poses a potential threat to the financial stability in the United States. In the case of CHIPS, CLS and DTC, settlement activity is highly concentrated amongst their largest members.¹¹⁴ CHIPS and CLS have liquidity and funding arrangements with the same large members. In the case of CLS these large members also provide third party services to financial institutions that are not a direct member of CLS. In the case of CCPs, a few commercial banks and their affiliates fulfill roles of settlement bank, custodian, depository banks, liquidity provider and general clearing member (clearing for clients). FMIs are operationally dependent on these commercial banks to access Fed services, such as Fedwire Funds and Fedwire Securities Services. The commercial banks also act as depositories for cash collateral and custodians for securities collateral. As liquidity providers they grant credit lines to the FMIs to draw upon in case they face liquidity strains. As general clearing members they and/or their affiliates provide access to the CCPs and CSD for clients that cannot become a direct member of the FMIs themselves. Last but not least these commercial banks and/or their affiliates may be of critical importance during a default of a clearing member to help the CCP liquidate and hedge the defaulter's positions and take over the positions of the defaulter's clients. The dependencies of systemically important FMIs on commercial bank services are described in Appendix 8. At least two G-SIBs are crucial to stable operations of nearly all U.S. FMIs.

106. Concentration risks should be actively mitigated. Designated FMUs and their authorities are aware of these risks and are further increasing the number of service providers. Still, given the current system-wide concentration of service provision by only a very few G-SIBs, the default of one of these banks can have system wide repercussions. For example, all CCPs will have to manage the default of the G-SIB as clearing member, and in addition, may temporarily or permanently lose access to collateral that is kept by the G-SIB in its role as custodian.¹¹⁵ The CCPs may lose access to their credit lines and face operational problems due to the loss of one of their settlement banks. The

¹¹³ The OFR has discussed this work in its annual reports and in working papers looking at network analysis and agent-based modeling.

¹¹⁴ See Appendix A of the 2012 FSOC report.

¹¹⁵ A legal determination may need to be made as to whether access is permanently lost.

recovery and resolution planning of banks may help reduce the risk of their failure, but does not ensure there would not be any disruption in the services provided to FMIs. As all FMIs will be hit simultaneously by the default of a G-SIB that fulfills services to a multitude of FMIs, it is important that this risk is further mitigated.

107. The provision of Fed accounts and services to systemically important FMUs has the potential to reduce their dependency on commercial banks' services. The Federal Reserve is encouraged to provide accounts and services to designated FMUs in line with the DFA and the relevant final rule of December 2013, which also recognizes the need to avoid undue credit, settlement, or other risk to the Federal Reserve Bank.¹¹⁶ Access to Fed accounts and services would enable CCPs to keep cash and securities collateral at the central bank, reducing their dependence on commercial banks. The account may also be used for settlement purposes. Extension of settlement in central bank money to systemically important CCPs, in particular the FICC, OCC, CME and ICE Clear Credit, will indeed further reduce credit and liquidity risks related to the use of settlement banks.

- *It is recommended that central bank services be offered to designated FMUs, i.e., access to Fed accounts and settlement in central bank money, consistent with avoiding undue credit, settlement or other risk to the Fed.*

108. Given the increased systemic importance of CCPs, it is crucial to pursue work on further risk mitigation. Much has been done during recent years to increase the robustness of the CCPs, in particular the adoption and implementation of the PFMI. Indeed, implementing adequate risk management requirements for CCPs is important to ensure that CCPs are robust enough not to become the next too-big-to-fail financial institutions. However, increased awareness of additional risks, both in the public and private sector, warrant further analysis, such as stress testing pursuant to the PFMI, harmonized margin requirements pursuant to the PFMI, recovery planning that addresses system wide risks, the adequacy of CCPs' loss absorbing capacity pursuant to the PFMI, and continued coordination between the supervisors of CCPs and their main clearing members.

- *U.S. authorities are therefore encouraged to continue efforts toward and monitoring of CCP robustness, through enhanced risk management standards and robust supervision.*¹¹⁷

D. Crisis Management Arrangements

109. U.S. authorities should ensure appropriate crisis management arrangements for FMIs, both domestically and internationally. Crisis arrangements are formalized only for a few FMIs. It is important to ensure that such crisis arrangements are formalized and tested at least for each of the

¹¹⁶ Regulation HH sets out the conditions and requirements for a Federal Reserve Bank to open and maintain accounts for and provide financial services to designated FMUs.

¹¹⁷ See also SEC's Regulation Systems Compliance and Integrity, Exchange Act Release No. 34-73639 (Nov. 19, 2014). 79 CFR 72251 (Dec. 5, 2014).

FMUs. This would include a description of rules and procedures defining the role and responsibilities of each agency in a crisis, and a comprehensive overview of possible crisis management measures, both for operational and financial disruptions. This includes also regular contingency planning exercises, in close consultation with the various U.S. supervisory agencies, to focus on issues spanning across institutions and sectors, in particular because a large participant's default would impact most U.S. FMIs simultaneously. MOUs with foreign authorities should also include crisis management arrangements when appropriate, as well as macroprudential information sharing.

- *U.S. authorities are encouraged to formalize and test crisis management arrangements for designated FMUs, where appropriate both domestically and internationally.*

110. Recovery and resolution work for FMIs is at an early stage. As a first step, recovery plans need to be finalized as soon as possible, aiming at enabling the FMI to sustain critical operations and services. Despite enhanced risk management and recovery planning, the risk that a CCP defaults cannot be entirely eliminated. A resolution framework aiming at maintaining financial stability while avoiding bail-out in the event of a default of a CCP is therefore important. U.S. agencies are currently discussing how FMIs would be resolved in the event of a failure. The U.S. authorities are encouraged to further develop a resolution framework for FMIs in line with the work led by the Financial Stability Board (in particular through the FSB Key Attributes).¹¹⁸

- *Recovery and resolution planning for FMIs should be further developed in line with international guidance.*

HOUSING FINANCE

111. Mortgage markets are integral to the overall stability of the U.S. financial system, and were at the epicenter of the 2008–09 crisis. While a number of important steps have been taken to address the structural weaknesses exposed by the crisis, GSE reform remains the largest piece of unfinished business. Nearly a decade after the crisis's onset, there remains no clarity of when Fannie Mae and Freddie Mac will exit conservatorship or consensus on the shape of a reformed housing finance system. This creates not only fiscal but also financial risks: moral hazard from coverage of credit losses by the government, a distorted competitive landscape due to the big footprint of these GSEs, and large subsidies for debt-financed homeownership generate incentives for excessive risk taking by investors and lenders and high levels of household indebtedness.

¹¹⁸ See FSB, Key attributes for resolution, 2014, with specific guidance for FMIs and their participants in Annex 1 of Appendix II.

112. The systemic importance of the U.S. housing market stems from several of its features.

Home mortgages, at some \$10 trillion, are the largest component of nonfinancial private sector debt (Figure 8), and most are securitized, generating strong interconnections not only with the rest of the U.S. financial system but also with the rest of the world.¹¹⁹ Implicit (and explicit) government guarantees are an important part of the U.S. mortgage securitization market. Government-backed securitization is important in transferring the risk of 30-year fixed-rate mortgages to private investors worldwide, who often do not want to engage in credit valuations of U.S. mortgages. Securitization also provides small depository institutions with a mechanism through which to gain access to liquidity, avoid overexposure to regional housing markets, and transfer interest rate risk. And the system facilitates continued provision of 30-year fixed-rate mortgage with no prepayment penalty—which is unusual by international standards and imposes both costs and risks that seem unnecessary given that most borrowers do not need to fix the rate for that long and typically refinance in less than 10 years.¹²⁰

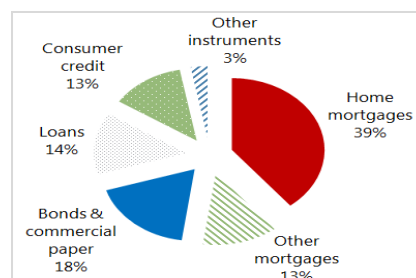
Figure 8. Private Nonfinancial Sector Debt (2014Q3)

Sources: Flow of Funds; staff calculations.

113. The federal government dominates the market. It stands behind more than 60 percent of the stock of loans and backs almost 80 percent of new single-family loan originations through FHA insurance, VA guarantees, and the activities of Fannie Mae, Freddie Mac, and Ginnie Mae (Figure 9).

114. Private label securitization (PLS) has largely disappeared (Figure 10). Deficiencies in the mechanisms for mitigating asymmetric information and conflicts of interest were exposed during the crisis and have alienated the investor community. Several steps have been taken to improve disclosure and better align the interests of different parties involved (see below). Adjustment to new regulations and rebuilding of confidence in the market will inevitably take some time but there are various other factors related to

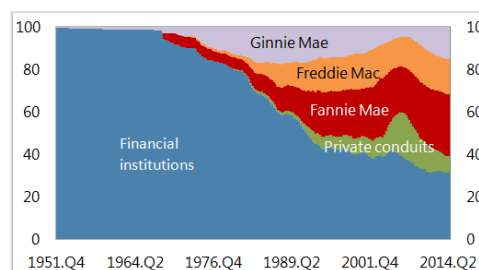
Figure 9. Mortgage Debt by Holder (Percent of total outstanding)

Sources: Federal Reserve Board; staff calculations.

¹¹⁹ The United States is an outlier in the use of securitization in housing finance. Deposit funding dominates mortgage lending in most countries—see, for instance, Figure 11 in Lea et al (2010), available at <http://www.housingamerica.org>.

¹²⁰ The fixed-rate mortgage share also has implications for monetary policy transmission. When house prices decline rapidly, fixed-rate mortgage holders that are under water find it difficult to refinance at lower rates. Home Affordable Refinancing Program (HARP) was initiated to address this problem.

the private securitization market—in particular, private sector mortgage insurance—that warrant a more proactive stance. Government insurance and guarantees are at times priced based on social policy objectives rather than long-term cost recovery, and the high-loan limits for qualifying mortgages mean that government cover is available to most new loans, making it difficult for the private sector to enter the market.

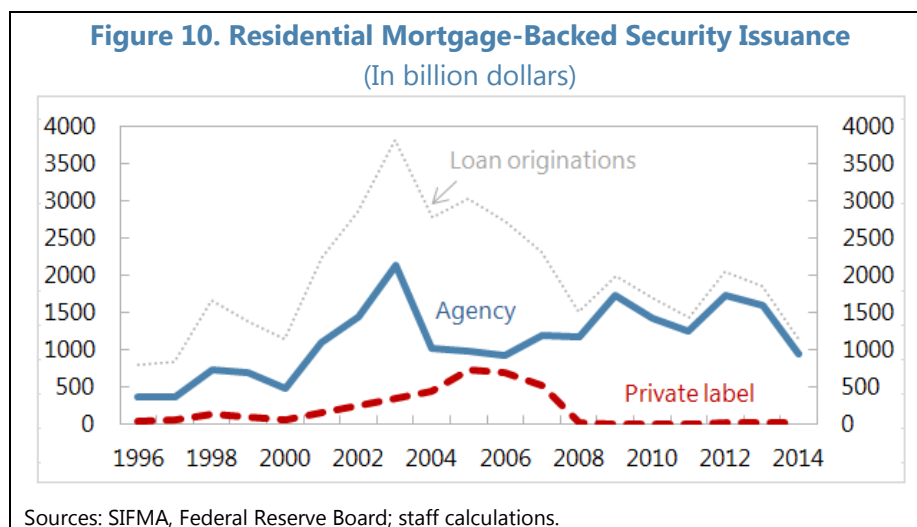

115. The current system continues to generate both costs and systemic risks:

- *Distorting competition.* The special status of Fannie Mae and Freddie Mac includes the ability to borrow cheaply owing to implicit government support (which became explicit at the onset of the crisis), lower capital requirements (which were suspended during the conservatorship), and exemption from state and local taxes. Similarly, insurance provided by the FHA may be priced, in part, on the basis of social goals rather than the risk of the loans, which discourages private mortgage insurance.
- *Moral hazard.* In addition, prior to entering conservatorship, Fannie Mae and Freddie Mac may have discouraged proper underwriting and monitoring due to weaknesses in quality control processes and ‘reps and warrants’ frameworks. The FHFA, under the conservatorship, has pushed Fannie Mae and Freddie Mac to strengthen these processes. Until these rules are fully embedded, the fear that loan originators may be forced to take back nonperforming loans onto their balance sheet and possible reputation (and litigation) risks associated with what may later be perceived as inappropriate lending practices, are dampening willingness to lend.
- *Risks to public balance sheet.* The crisis demonstrated the fiscal risks from the implicit guarantee: on a fair-value basis, the estimated cost of federal subsidies over the coming 10 years on new loan guarantees is \$19 billion (CBO, 2014).
- *Costly cross-subsidization of social policy.* Housing affordability and homeownership rates in the United States are broadly in line with other OECD countries, but are achieved at a significantly higher cost in terms of implicit fiscal subsidies—including through mortgage interest

deductions in the personal income tax and the quasi-fiscal costs borne by Fannie Mae and Freddie Mac.¹²¹

- *Supervisory and regulatory complexity.* The existing construct leaves the FHFA in the role of both conservator and regulator of Fannie Mae and Freddie Mac, exposing it to the appearance of a conflict of interest. Oversight of nonbank mortgage servicers—which may be posing increasing risk—appears to be, in large part, exercised indirectly by FHFA guidance to Fannie Mae and Freddie Mac and by the consumer-protection standards issued by the CFPB.¹²²

116. In the past few years, there has been progress in a number of areas. Spearheaded by Title XIV (Mortgage Reform and Anti-Predatory Lending) of the DFA with an important role for the newly-established CFPB, this progress has also involved actions by the other agencies:

- **Ability to repay and QM:** The CFPB requires lenders to make a reasonable and good-faith determination that the borrower can meet their obligations. A loan that meets certain criteria is deemed to be a Qualified Mortgage (QM) and enjoys a safe harbor from legal challenges. These rules went into effect in January 2014.¹²³
- **Consumer protection:** Rules to curb certain practices have been issued by the CFPB. These include loan originator compensations requirements, high-cost mortgage provisions (effective January 2014), and integration of mortgage disclosure requirements (effective August 2015).
- **National mortgage servicing standards:** CFPB servicing rules govern how servicers are to process payments, notify borrowers of interest rate changes, resolve errors, and provide monthly statements, and treat loan modification applications, among other servicing functions. Compared to pre-crisis, servicing rules have been strengthened. These rules went into effect in January 2014.
- **Risk retention and QRM:** The risk retention rule to implement Title IX of the DFA includes definition of a Qualified Residential Mortgage (QRM). Mortgage loans eligible for sale to the secondary market for securitization must include either a 5 percent risk retention requirement or meet standards exempting loans from risk retention. QRMs are those loans meeting the new

¹²¹ The benefits of these implicit fiscal costs for the most part accrue to the upper-income households and have little effect on promoting homeownership.

¹²² Servicers must continue advancing payments to lenders and investors for a period even after a borrower defaults. Hence, failure of a servicer could clog the system and generate problems for other participants in mortgage markets. Capital and liquidity requirements provide a buffer to this risk in the case of bank servicers, but the requirements for appropriate buffers in the case of nonbank servicers are not clear.

¹²³ However, under its own underwriting guidelines, FHFA has adopted some but not all QM requirements. A 'patch' to the QM exempts loans purchased by Fannie Mae and Freddie Mac from the QM rule until January 10, 2021 or the end of conservatorship, whichever happens first.

standard and exempt from risk retention. The definition of QRM is aligned with that of QM.¹²⁴ The QRM definition will be reviewed four years after it becomes effective (December 2015), and every five years thereafter.

- **Credit rating agency (CRA) reform:** CRAs play a crucial role in the securitization process. The crisis has revealed deficiencies not only in CRA models but also the inherent conflicts of interest. The SEC issued new rules in August 2014 to boost ratings quality and increase CRA accountability. CRAs must erect strict boundaries between sales staff and employees handing out ratings to the securities, have procedures to conduct look-back reviews, review annually the internal controls in place and disclose credit rating performance statistics. Many of the rules became effective in late 2014 and January 2015, with the remainder in June 2015.
- **FHFA actions:** Under the conservatorship, the agency has reduced the retained portfolios of Fannie Mae and Freddie Mac, strengthened the regulatory oversight of the GSEs, promoted credit-risk sharing transactions, provided clarity on ‘reps and warrants’—which govern the put-back decisions—and has been working on mortgage data standardization, a common securitization platform, and standards for nonbank servicers and private mortgage insurers.

117. Nonetheless, further actions are needed in some areas to address the systemic risks that were exposed during the crisis. For example, although foreclosures and delinquencies have decreased significantly, some banks are still saddled with large legacy loans. Reducing litigation risks (e.g., by expediting remaining PLS cases and settlements) and continuing the progress with loan workouts could help. In addition, and notwithstanding FHFA steps since 2012 to address concerns about put-back risk that have mitigated banks’ reluctance to get back in the mortgage origination and securitization business, further steps could be contemplated. These could include providing alternative dispute resolution processes and cure mechanisms for non-material mistakes and lower-severity defects that do not directly affect mortgage default probability (FHFA is working to provide clarity on these issues).

118. It is essential that the authorities move swiftly to complete the reform of the U.S. housing market. Several legislative proposals have been introduced in Congress to complete the reform of Fannie Mae and Freddie Mac, and these share most of the broad goals that were recommended in the 2010 FSAP:

- Winding down Fannie Mae and Freddie Mac investment portfolios within a well-defined time period;¹²⁵

¹²⁴ Originally proposed QRM rules imposed a down payment requirement but this was dropped in the final version based on the determination that the benefits of aligning the rule with QM would outweigh the incremental benefit of including an LTV on expected default rates.

¹²⁵ From March 31, 2009 through December 31, 2014, Freddie Mac’s retained portfolio has decreased from \$867 billion to \$408 billion, while Fannie Mae’s has decreased from \$784 billion to \$413 billion. Agreements with the Treasury require each portfolio to be below \$250 billion by December 31, 2018.

- Leveraging the government’s role in the market (including via Fannie Mae and Freddie Mac) to support standardization and computerization of mortgage data;
- A sizeable first-loss risk borne by private capital and a public backstop that is strictly limited to catastrophic losses and is funded by risk-based guarantee fees;
- Clear separation of roles for promoting access to credit and ensuring the stability and safety of the mortgage market;
- Reducing cross-subsidization and market distortion by charging separately and appropriately for prepayment of fixed-rate mortgages.

119. Emerging risks—including those stemming from the regulatory environment—should be monitored carefully. In particular:

- More clarity is needed in the regulatory framework for non-bank mortgage servicers. There has been a notable increase in nonbanks’ share of mortgage servicing. The increased regulatory burden and legal liabilities associated with the CFPB’s new servicing rules, combined with Basel III’s capital treatment of mortgage servicing assets, appears to be resulting in a shift of this function to nonbank servicers. More banks now elect to sell mortgages into the secondary market “servicing released” or to divest their servicing portfolios. The FHFA has started work on revision and alignment of servicer eligibility requirements.
- Steps are needed to enhance the capacity of the private sector to deliver mortgage insurance, if the government sector is to step back. Although mortgage guarantees play an important role in the U.S. housing finance market (and provides an important alternative to FHA guarantees), only 3 percent of the private insurance industry is involved in mortgage insurance. The industry was hit hard by the crisis: of the eight insurers writing private mortgage insurance in 2000, only five remain active and, because of credit rating downgrades, they have been operating under waivers for the counterparty standards. It is encouraging that recently the industry has attracted new capital both through the formation of two new mortgage insurers and through capital raised by the legacy mortgage insurers. State insurance regulators and the FHFA are in the process of developing new capital standards and market regulations that aim to enhance the long-term viability of this insurance line.
- As noted earlier, there is scope for a stronger role for the FSOC in the discussion and analysis of macroprudential policies relating to the housing market, in order to maximize coordinated actions by separate agencies. This could include the possible use of QM and QRM standards for macroprudential purposes as well as consideration as to how other possible tools such as LTV ratios might be used.
- Especially in the light of the prospect of the normalization of monetary conditions, continued work on assessing and ameliorating interest rate risk by relevant supervisory agencies is essential.

Appendix 1. Remit and Organization of the Financial Stability Oversight Council

Remit: The FSOC was established by the DFA in 2010 with three primary purposes:

- To identify risks to the financial stability of the United States that could arise from the material distress or failure, or ongoing activities, of large, interconnected bank holding companies or nonbank financial companies, or that could arise outside the financial services marketplace.
- To promote market discipline, by eliminating expectations on the part of shareholders, creditors, and counterparties of such companies that the U.S. government will shield them from losses in the event of failure.
- To respond to emerging threats to the stability of the U.S. financial system.

Membership: The Council has 10 voting members, and 5 non-voting members who serve in an advisory capacity:

Voting members:

- Secretary of the Treasury (who serves as Chair of the Council);
- Chair, Board of Governors of the Federal Reserve System;
- Chairperson, Federal Deposit Insurance Corporation (FDIC);
- Chair, Securities and Exchange Commission (SEC);
- Chair, Commodity Futures Trading Commission (CFTC);
- Director, Consumer Financial Protection Bureau (CFPB);
- Director, Federal Housing Finance Agency (FHFA);
- Comptroller of the Currency (OCC);
- Chair, National Credit Union Administration (NCUA);
- Independent Member with Insurance Expertise.

Non-Voting members:

- Director, Office of Financial Research, Department of the Treasury (OFR);
- Director, Federal Insurance Office, Department of the Treasury (FIO);

- A state insurance commissioner designated by the state insurance commissioners;
- A state banking supervisor designated by the state banking supervisors;
- A state securities commissioner (or officer performing like functions) designated by the state securities commissioners.

Committees: The FSOC is supported by a Deputies Committee of senior staff from member agencies. In turn, the Deputies Committee directs and oversees the work of six Committees addressing: Systemic Risk; Designation of Nonbank Financial Companies; Designation of FMUs and Payment, Clearing and Settlement Activities; Heightened Prudential Standards; Orderly Liquidation Authority and Resolution Plans; and Data (see Figure 11).

Secretariat: The Council is supported by a dedicated Secretariat of just over 20 staff at the U.S. Treasury.

Meetings: The Council must meet at least quarterly, but in practice has met approximately monthly on average since inception. Public notice of meetings is provided at least 7 days in advance. Summary readouts of meetings are provided immediately after each meeting. Minutes are approved and published immediately after the subsequent meeting.¹

Decision making: The base case for FSOC votes is a general majority of voting members. For several specific decisions tighter criteria are applied. In particular, votes on designation of nonbank companies and FMIs require a vote of no fewer than 2/3 of the voting members then serving, including an affirmative vote of the Chair. Other criteria require different voting majorities. For example, section 121 of DF on actions to mitigate threats to financial stability when there is a 'grave threat' and section 119 on resolution of disputes among agencies both require an affirmative vote of no fewer than 2/3 of the voting members then serving (i.e., there is no requirement for an affirmative vote of the Chair).

Accountability: The FSOC is accountable to Congress through the publication of an Annual Report and through testimony to Congress on the FSOC's activities and emerging threats to financial stability.

¹ No transcripts of meetings are prepared for release at a later date.

Appendix Figure 1. Organizational Structure of FSOC

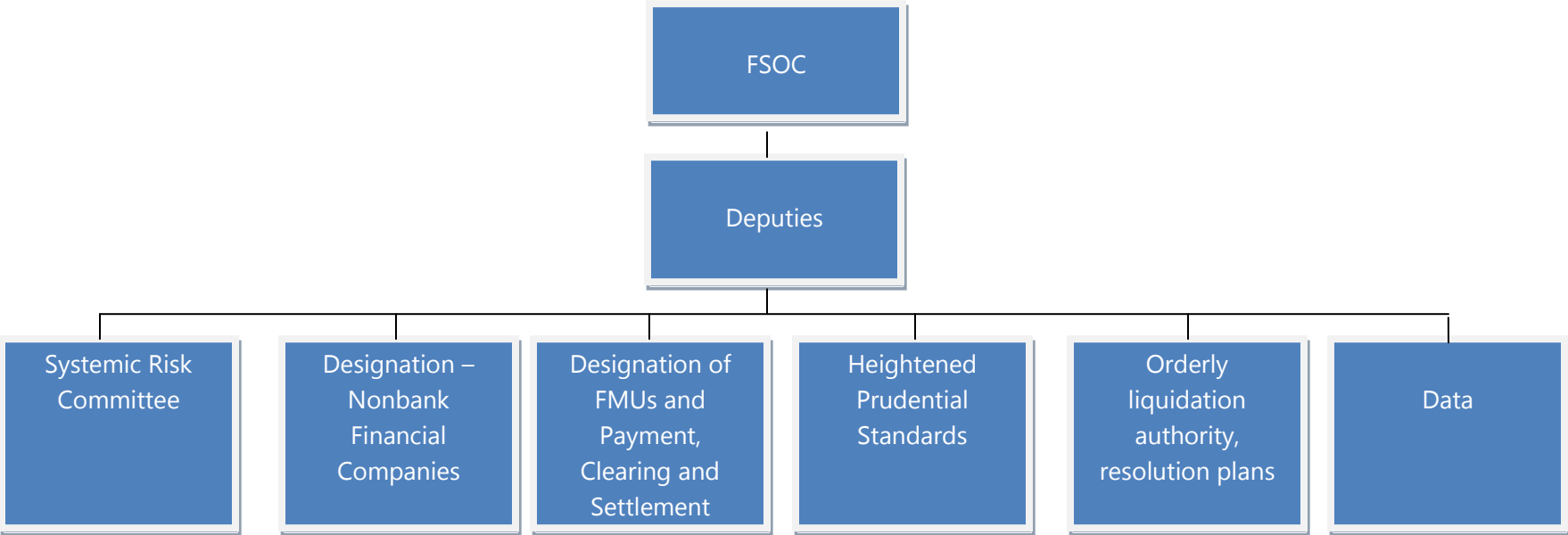

Appendix 2. The Office of Financial Research

The Office of Financial Research was established by the DFA within the Treasury Department to serve the Council, its member agencies and the public by improving the quality, transparency, and accessibility of financial data and information. Particular tasks include:

- Collecting data on behalf of the Council, and providing such data to the Council and member agencies;
- Standardizing the types and format of data reported and collected;
- Performing applied research and essential long-term research;
- Developing tools for risk measurement and monitoring.

A major task of the OFR is to develop and improve information and data by promoting standards and addressing data gaps. To take this forward, the Office has compiled and maintains an inventory describing the data that Council member agencies purchase or collect. Drawing on this and an assessment of gaps, the OFR is currently particularly focusing on: filling gaps in secured funding markets, including securities lending and repo markets,^{1/} as well as exploring gaps in areas such as captive reinsurance, mortgages and other markets, and asset management activities. In relation to standards, the OFR has actively supported the advancement of the global LEI system, and is also working on a strategy to develop a unique mortgage loan-level identifier, as well as supporting the CFTC in the global discussions on the alignment and standards for derivatives reporting. The Office is also leading the work across FSOC member agencies to develop protocols and procedures for securely sharing data for monitoring and analysis.

The OFR is also heavily involved in research and development of improved tools for financial stability analysis. The Office has developed a Financial Stability Monitor to address five components of financial stability risk (macroeconomic, market, credit, funding and liquidity, and contagion) in the form of a snapshot or 'heat map', and is building a suite of monitoring tools to assess risks to the financial system.^{2/} Outputs from these tools will be presented regularly to FSOC and its Systemic Risk Committee—a version of a Financial Markets Monitor summarizing major developments and trends in global capital markets is already in regular use. The Monitor will be published monthly—the first public release was in February 2015.

^{1/} A pilot project to collect information on bilateral repo markets have recently been announced. The project is taken forward jointly by the OFR, FRB and FRBNY.

^{2/} See: OFR Annual Reports for 2013 and 2014.

The OFR has some operational independence from FSOC. OFR is charged with preparing an independent annual report to Congress on the state of the U.S. financial system, including an analysis of any potential threats to financial stability. Such reports are timed to be issued mid-way between the FSOC Annual reports. The OFR also has specific statutory responsibilities to evaluate and report on stress tests and on the impact of policies related to systemic risk. Because of these responsibilities and because it is not charged with setting policy, the OFR may provide an objective appraisal of financial stability tools.

The OFR has grown rapidly from some 30 staff in Fiscal Year 2011, to nearly 225 in December 2014. The steady state staffing level is expected to be around 300.

Appendix 3. Macroprudential Policy Tools in the United States

Policy tool	Within planned U.S. framework	Implementation Date (if applicable)	Implementing Agencies	Trigger / Threshold	Comment
Structural resilience^{1/}					
Additional capital surcharge for G-SIBs	Yes	Phased in over Jan 2016 to Dec 2018	FRB	8 US G-SIBs ^{2/}	Strengthening of FSB Standard. Includes funding risks element
Enhanced supplementary leverage ratio	Yes	Jan 2018	FRB, FDIC and OCC	8 US G-SIBs	Enhancement of Basel III standard (5 percent for G-SIBs)
Enhanced liquidity standards for systemic banks	Yes	Phased in over Jan 2015 to Dec 2016	FRB, FDIC and OCC	8 US G-SIBs + banks >\$250 billion apply full U.S. LCR	Full US LCR enhancement from Basel. LISCC firms subject to CLAR ^{3/}
Enhanced single counterparty exposure rules for systemic banks	Yes	To be decided			U.S. rules to be finalized
Designation and heightened prudential standards (nonbank SIFIs)	Yes	Higher prudential standards to be decided —implementation date uncertain	FSOC, FRB	FSOC designations. FRB to apply heightened prudential standards	
Designation and heightened prudential standards (FMIs)	Yes	8 designations so far	FSOC, FRB, SEC, CFTC	FSOC designations Standards applied by FRB, SEC, CFTC	Rules adopted by the CFTC and the FRB, but not yet the SEC

^{1/} Stress testing also provides an important tool to support structural resilience. (See <http://www.federalreserve.gov/bankinforeg/stress-tests-capital-planning.htm>) See also the accompanying Technical Note on stress testing.

^{2/} See: Tarullo (2014) "Rethinking the aims of Prudential Regulation."

^{3/} LISCC (Large Institutions Supervision Coordinating Committee)—A Federal Reserve committee to oversee supervision of the largest financial institutions (currently 16). CLAR (Comprehensive Liquidity Assessment Review).

Appendix 3. Macroprudential Policy Tools in the United States (continued)

Policy tool	Within planned U.S. framework	Implementation Date (If applicable)	Implementing Agencies	Trigger / Threshold	Comment
Systemic Liquidity and Run Risks					
Enhanced liquidity standards for banks ^{4/}	See above for LCR. The United States will also propose and implement NSFR rules	Uncertain	FRB		
NAV amendments and fees and gate amendments for MMMFs	Yes	2016 Q3	SEC		
Haircuts and margins	Yes	Initial and variation margin for repos and SFT available (last used in 1970s)	FRB		FRB reconsidering minimum margin requirements on additional form of securities credit ^{5/}
Tools to address cyclical buildup of risks					
Countercyclical buffers	Yes	2016 onwards (phased in Jan 2016 – Jan 2019)	FRB, OCC, FDIC	Firms >\$250 billion in assets or >\$10 billion in foreign assets. Application triggers under research	Normally requires 1 year notification of implementation ^{6/}

^{4/} See Governor Tarullo. <http://www.federalreserve.gov/newsevents/testimony/tarullo20140909a.htm>.

^{5/} The rule includes provision for faster implementation if an agency determines this is required.

^{6/} See Governor Brainard. <http://www.federalreserve.gov/newsevents/speech/brainard20141203a.htm>.

Appendix 3. Macroprudential Policy Tools in the United States (concluded)

Policy tool	Within planned U.S. framework	Implementation Date (if applicable)	Implementing Agencies	Trigger / Threshold	Comment
Altering capital risk weights on sectors / products	In principle ^{7/}	Available in principle			May require upwards of a year to implement ^{8/}
Other tools ^{9/}	Not at present				
Others – supervisory guidance	Yes	Implemented	Banking regulators		Applied recently in relation to leveraged loans

^{7/} See Governor Brainard. <http://www.federalreserve.gov/newsevents/speech/brainard20141203a.htm>.

^{8/} See Governor Brainard. <http://www.federalreserve.gov/newsevents/speech/brainard20141203a.htm>.

^{9/} See OFR Annual Report 2014 and Governor Brainard. <http://www.federalreserve.gov/newsevents/speech/brainard20141203a.htm>.

Appendix 4. Risks and Interconnectedness In and Around TPR

This diagram illustrates the TPR-related vulnerabilities exposed during the last crisis and does not attempt to show exhaustively all participant activities and interconnections.

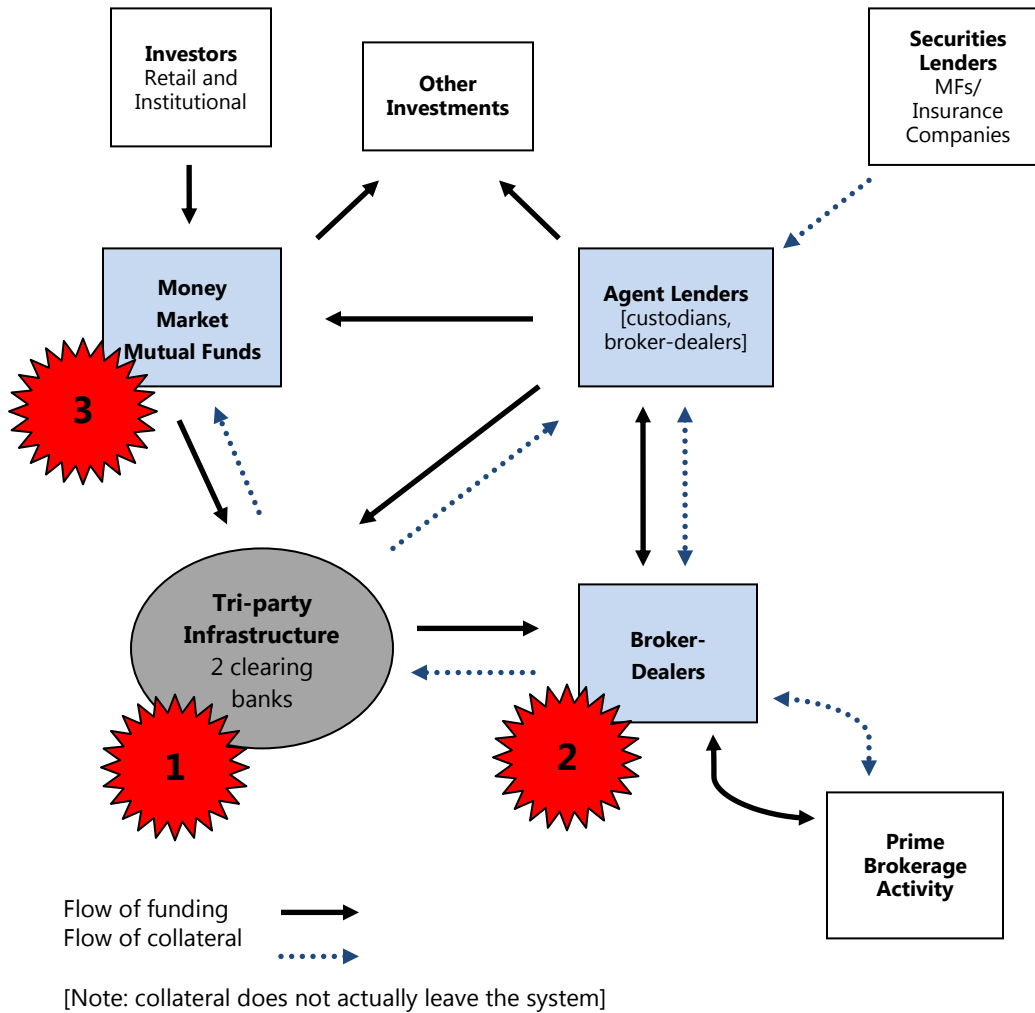

Vulnerabilities

1. Tri-party Infrastructure

Intra-day credit exposures. Reliance on two clearing banks.

Response

Reengineering of the operations with intra-day credit virtually eliminated.

Further Actions

Reduce reliance on the two clearing banks.

2. Broker Dealer Regulation

Excessive leverage and maturity transformation.

Supervisory pressure to term out repo books.

Complete review of broker-dealer rules.

3. MMMF Regulation

Inadequate regulations resulting in a run on the industry.

Investment tightened. New liquidity rules.

Stress testing requirements. Variable NAVs and gates and fees for some funds.

Tighten rules on repo collateral.

Move all funds to variable NAV.

Appendix 5. Statistics on Financial Market Infrastructures

Appendix Table 1. Statistics on FMIs, 2013				
System	Number of transactions (In million)	Value of transactions (In billion dollars)	Number of participants	Rank worldwide (based on value of transactions)
Payment systems				
CHIPS	103	379,984	50	3
CLS	205	1,291	65	1 (in FX transactions)
Fedwire Funds	134	713,310	6,930	2
Federal Reserve check clearings	6,171	8,137	na	na
Central securities depositories				
DTC	319	123,100	353, of which 89 banks and 264 other	8
Fedwire Securities Service	19	295,186	2,084, all banks	4
Central counterparties				
FICC	40	1,155,200	161, of which 37 banks and 124 other	1 (in government securities)
NSCC	17,723	207,220	173, of which 11 banks and 162 other	1 (in corporate securities)
	Number of contracts traded (In billion)	Value of transactions (In billion dollars)	Number of participants	
OCC	4.17	na	+/- 120	na
CME	na	15,092 (IRS) 227 (CDS)	69	2 (in OTC IRS)
ICE Clear Credit	na	7,645 (CDS)	30	1 (in OTC CDS)

Sources: BIS, Futures Industry Association, disclosure frameworks OCC, CME and ICC.

**Appendix Table 2. CCPs Offering OTC Derivatives Clearing
(Notional amount outstanding, April 2014)**

CCP	IRS	IRS Futures	CDS	FX
U.S.				
ICE Clear Credit			\$928 billion	
CME	\$27 trillion	\$11 billion	\$54 billion	
Eris		\$10 billion		
LCH.Clearnet LLC (U.S. (SwapClear service))	\$26 billion			
Europe				
ICE Clear Europe			\$349 billion	
CME	Not public			
Eurex	\$29.5 billion			
LCH.Clearnet Ltd.	\$401 trillion		\$40 billion	\$117 billion
Asia				
Singapore Exchange	\$32.1 billion			\$214 million
Hong Kong Exchange	\$700 million			
Japan SCC	\$14 trillion		\$8 billion	
CCIL India	Small			
Shanghai Clearing House	\$1 billion			
Source: OTC Space.				

**Appendix Table 3. CCP Size of Financial Resources, December 2013
(In billion dollars)**

CCP	Size of margin	Size of clearing fund	Comments
FICC		19.7 ^{1/}	Data as of June 30, 2014. Of the total deposits 11.1 is in cash and 8.5 in securities.
NSCC		4.4 ^{2/}	Data as of June 30, 2014. Of the total deposits 4.2 is in cash and 0.2 in securities.
OCC	102	4	Data as of December 31, 2013
CME	na	CME has 3 guarantee funds: Base 3.2 CDS 0.7 / IRS 1.2	Data as of December 31, 2013 The data concern the calculated guarantee fund. Actual deposits are higher.
ICE Clear Credit	16	1.9	Data as of September 30, 2014 The clearing fund consists of 1.86 contributions from clearing members and 50 million of ICC. The data includes excess collateral.
Source: Disclosure frameworks of individual CCPs available on their website.			
^{1/} FICC collects margin and other deposits and refers to them collectively as the clearing fund.			
^{2/} NSCC collects margin and other deposits and refers to them collectively as the clearing fund.			

Appendix 6. FMI Landscape

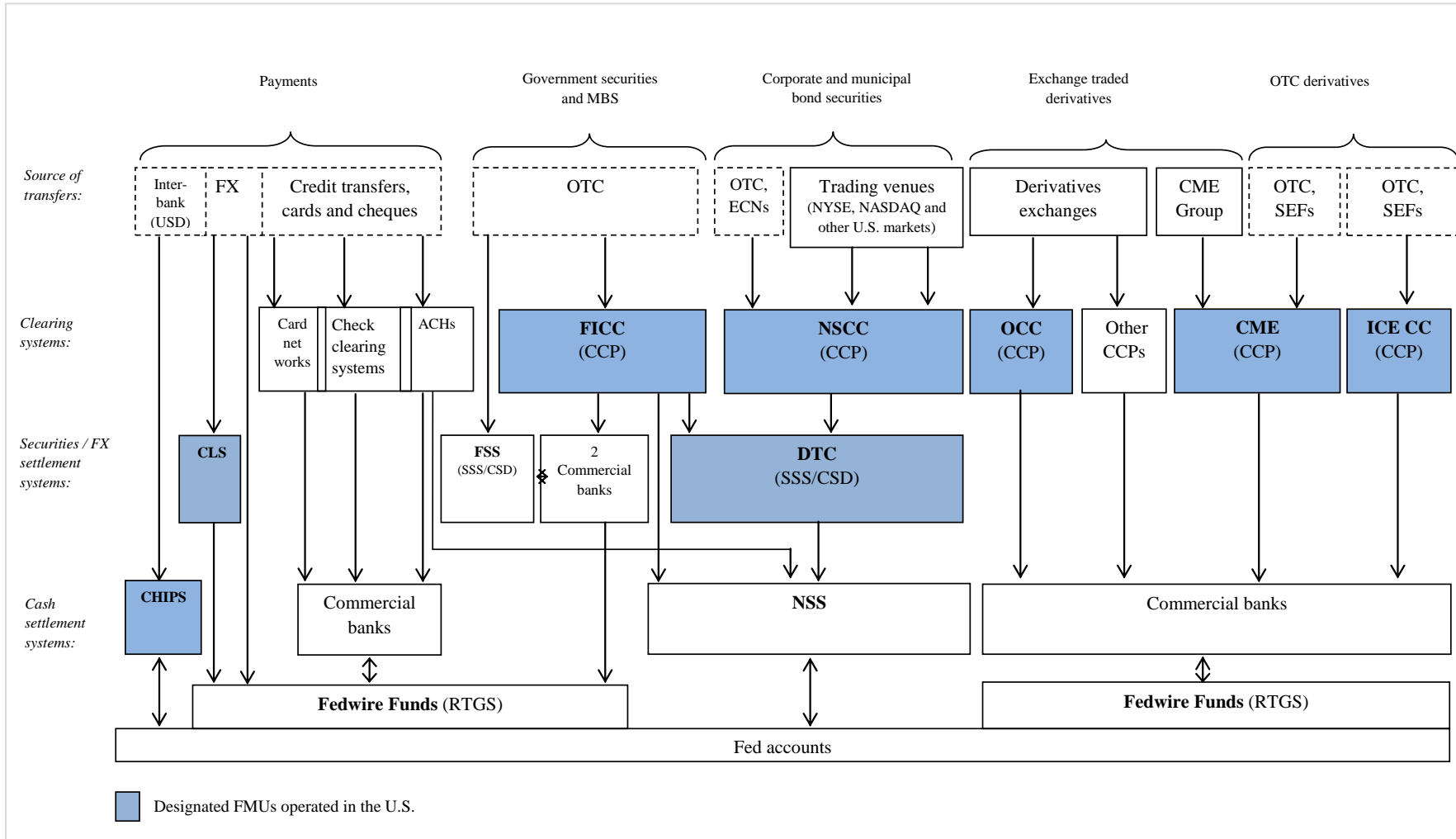

Appendix 7. Cross-Margining Arrangements and CSD Links

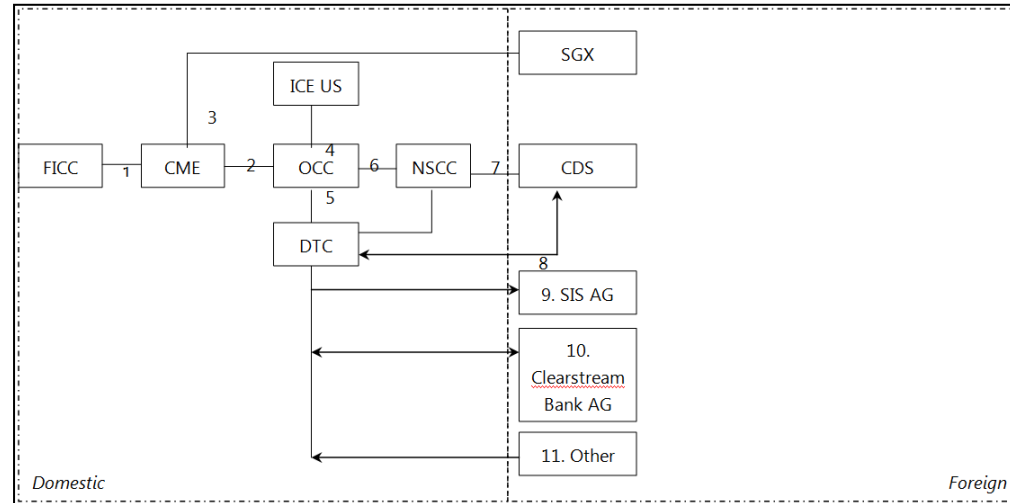

	FMI ^s involved	Description
1.	FICC, CME	Cross-margining arrangement
2.	CME, OCC	Cross margining arrangement
3.	CME, Singapore Exchange	Mutual Offset System Agreement, which enables traders to open a futures position on one exchange and liquidate it on the other.
4.	OCC, ICE U.S.	Cross margining arrangement
5.	OCC, DTC	Disbursement Program, which facilitates the payment of stock settlement obligations of common OCC clearing members and NSCC participants resulting from exercised and assigned equity options.
6.	OCC, NSCC	Disbursement Program, which facilitates the payment of stock settlement obligations of common OCC clearing members and NSCC participants resulting from exercised and assigned equity options.
7.	NSCC, CDS	CDS Clearing and Depository Services Inc. ("CDS"), the Canadian CSD and CCP, is a full service Member of NSCC
8.	DTC, CDS	CDS is a participant of DTC.
9.	DTC, Sega Intersectle	DTC is a participant of Sega Intersectle, the Swiss CSD
10.	DTC, Clearstream Bank Frankfurt AG	DTC and Clearstream Banking Frankfurt are participant in each other's CSD
11.	DTC, other	Other CSDs are a participant of DTC, i.e. Investor CSDs that have DTC participant accounts with DVP settlement services are CAVALI, Peru; Merval, Argentina; and Depósito Central de Valores, Chile. Other Investor CSDs that have DTC accounts for free of payment transaction only, with no cash services other than corporate actions and billing are CREST International Nominees Ltd., UK and Ireland; Caja de Valores, S.A., Argentina; Tel Aviv Stock Exchange Clearing House (TASECH), Israel; Monte Titoli, S.p.A., Italy; Japan Securities Depository Center, Inc.; Central Depository (Pte.) Ltd., Singapore; and Hong Kong Securities Clearing Company Limited.

Appendix 8. Dependencies of Designated FMUs on Commercial Bank Services

Designated FMU	Settlement bank	Collateral services	Liquidity/Funding services	Other
Payment systems				
CHIPS	Not applicable	Not applicable	Small group of funding agents acting on behalf of non-funding participants.	A relatively large percentage of the value of the payment messages is concentrated within a small number of participants.
CLS	Not applicable	Not applicable	CLS has committed credit lines in US dollar, provided by a few CLS members.	In 2011, the three largest US-based third party service providers account for more than 48 percent of total third-party activity.
Central securities depository				
DTC	For cash settlement DTC relies on settlement banks to make the payments from and to DTC's account at the FRBNY, with a high concentration at the top five settlement banks.	Cash collateral is held at the FRBNY. Securities collateral is held at accounts in DTC.	DTC's line of credit, established with a syndicate of 31 banks, totaled 2 billion USD at December 31, 2011. Canadian settlement is supported by a credit line of CAN\$150 million of a DTC participant.	-
Central counterparties				
CME	Settlement is concentrated in three large settlement banks.	The largest settlement banks are also the largest custodians. Overnight collateral kept as repos.	Credit facility is relatively evenly dispersed over 22 banks, including the settlement banks. Total value of credit lines was several billion U.S. dollars in 2011.	Some banks also act as general clearing member and/or help the CCP to liquidate and hedge the positions of a defaulting clearing member.

Appendix 8. Dependencies of Designated FMUs on Commercial Bank Services (concluded)

Designated FMU	Settlement bank	Collateral services	Liquidity/Funding services	Other
FICC	Two settlement banks settle cash and securities transactions.	The two settlement banks also keep the collateral.	Credit lines provided by a consortium of 30 banks, the majority of which are also clearing members.	Some banks also act as general clearing member and/or help the CCP to liquidate and hedge the positions of a defaulting clearing member.
ICE	Two settlement banks settle cash transactions.	The two settlement banks keep the collateral. Overnight collateral kept as repos.	ICE receives credit line from ICE Inc that receives credit from a syndicate of banks (10-12).	Some banks also act as general clearing member and/or help the CCP to liquidate and hedge the positions of a defaulting clearing member.
NSSC	Settlement is concentrated in a few settlement banks.	Cash collateral is held at the FRBNY through the DTC account. Securities collateral is held at accounts in DTC.	Credit line provided by a consortium of 15 banks.	Some banks also act as general clearing member and/or help the CCP to liquidate and hedge the positions of a defaulting clearing member.
OCC	Nine settlement banks, with volumes concentrated in three settlement banks.	The three settlement banks keep the collateral.	Credit lines of \$2 billion from a bank syndicate (some are also member) and \$1 billion repos from a pension fund.	Some banks also act as general clearing member and/or help the CCP to liquidate and hedge the positions of a defaulting clearing member.
Source: Based on FSOC Annual Report 2012—Appendix A and discussions with FMIs.				